



PIEDRA TECNOLÓGICA / LOSA SINTERIZADA

CATÁLOGO

2026

www.sinteredstone.com.mx



Somos un Grupo Empresarial que trabaja en colaboración contigo para asegurarnos de que tu proyecto de construcción se distinga por su diseño exclusivo y elegante. Nuestros productos te permitirán hacer elementos decorativos en tu construcción y su belleza por sí sola harán que sean el centro de atención en tu casa, edificio, oficina, hotel, plaza comercial, entre otros.

Somos pioneros en utilizar tecnologías avanzadas que nos permiten elaborar combinaciones y formatos **sin límite**, adecuándose y personalizando los espacios al estilo y gusto de cada uno de los clientes, brindando **exclusividad y autenticidad** en cada uno de los diseños.



NUESTRA EMPRESA

Ha logrado consolidarse como líder en la comercialización de Losas de Piedra Sinterizada en Ultra Gran Formato. Nuestra amplia variedad de diseños y formatos, combinada con un stock permanente de productos, brinda a nuestros clientes la confianza necesaria para llevar a cabo sus proyectos sin preocuparse por retrasos en los tiempos de entrega.

Actualmente, disponemos de centros de distribución en las siguientes ciudades:

- Cancun Q. Roo.
- Tecali de Herrera ,Puebla.
- San Francisco Totimehuacan, Pue.
- Oaxaca.



¿Qué es la Piedra Sinterizada?

La Piedra Sinterizada, también conocida como Piedra Tecnológica, se compone de ingredientes naturales derivados principalmente de tres elementos: Granito, Cuarzo y Feldspard. Estos componentes proporcionan al producto una combinación única de firmeza y flexibilidad.

Además, se incorporan derivados del Vidrio y del Cuarzo para asegurar la estabilidad de las losas de Piedra Tecnológica o Piedra Sinterizada. Un aspecto destacado de este material es la presencia de óxidos naturales que permiten la personalización de colores.

CARACTERÍSTICAS



Facilidad de Limpieza y Mantenimiento.



Superficie Higiénica



Idóneas para el Contacto con Alimentos



Superficie Compacta



Adecuado tanto para Ambientes Interiores como Exteriores



Resistente al Calor y las Altas Temperaturas



Resistente a las manchas:



Resistente a Productos de Limpieza y Detergentes:



Resistente a Productos Químicos, Ácidos, Bases y Disolventes



Resistente a la Humedad



Resistente a Rayaduras



Material 100% Natural



Material Reciclable



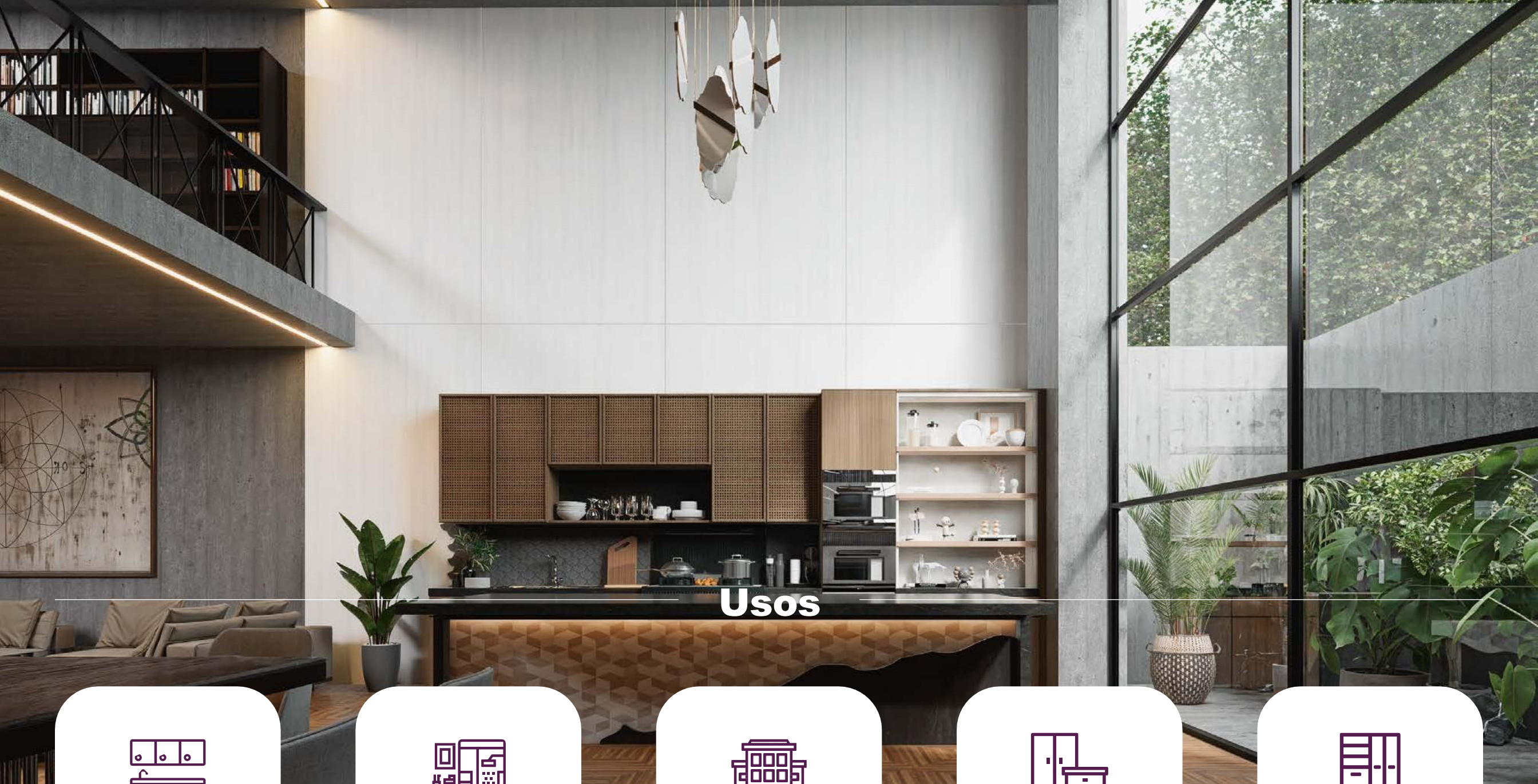

Usos

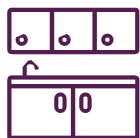

Cocinas



Baños



Exteriores



Muebles



Closets

Usos



Pisos



Muebles de TV



Muros Interiores

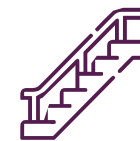

Pasillos de Escaleras



Posibilidades Infinitas

FORMATOS

*Ice Age



1200*2400*9mm

*Panda White



1200*2600*6mm
1200*2600*9mm

*Frapuccino



1200*2700*6mm

*Cartier Gold

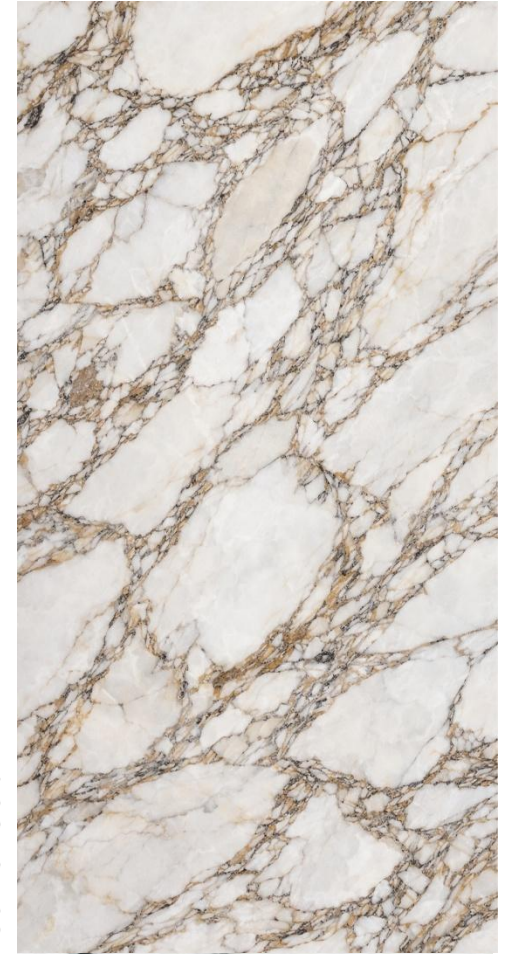

1600*3200*6mm
1600*3200*12mm

DIMENSIONES	ESPESOR EN MM	M ² POR LOSA	KG/LOSA	PESO EN KG X M ²
1200*2400	9	2.88	62	21.52
1200*2600	9	3.12	68	21.79
1200*2600	6	3.12	45	14.42
1200*2700	6	3.24	48	14.81
1600*3200	6	5.12	74	14.40
1600*3200	12	5.12	148	28.90



6MM

**PIEDRA TECNOLÓGICA /
LOSA SINTERIZADA**

1200 x 2600 x 6MM

PIEDRA TECNOLÓGICA /
LOSA SINTERIZADA

Amber Grey

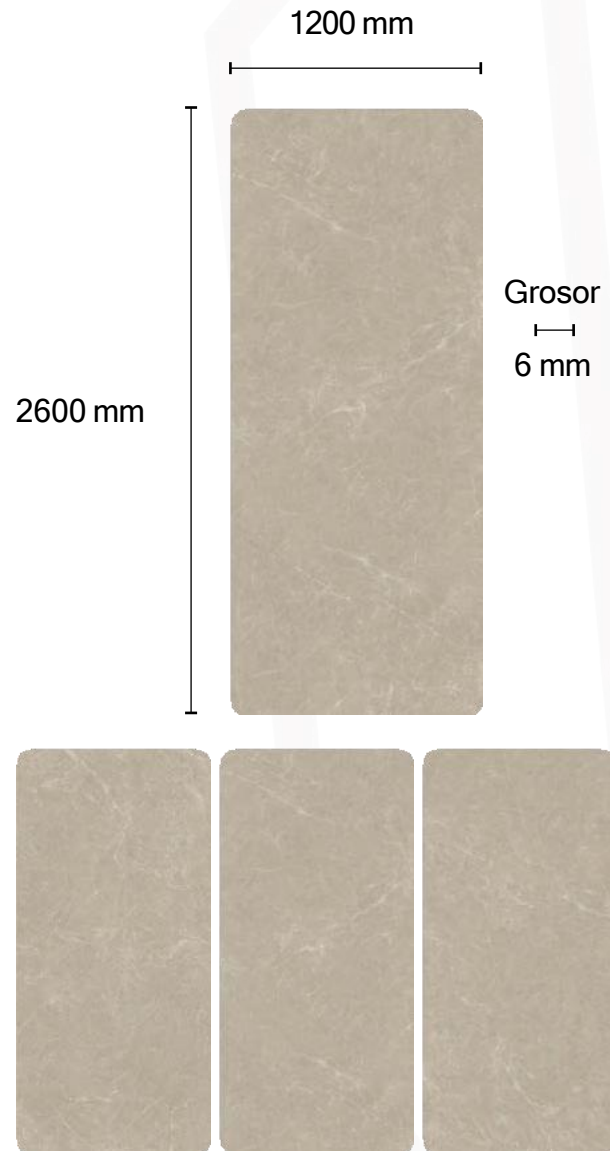

Acabado: **Pulido**

Secuencia Facial: **A B C**

Black Agate

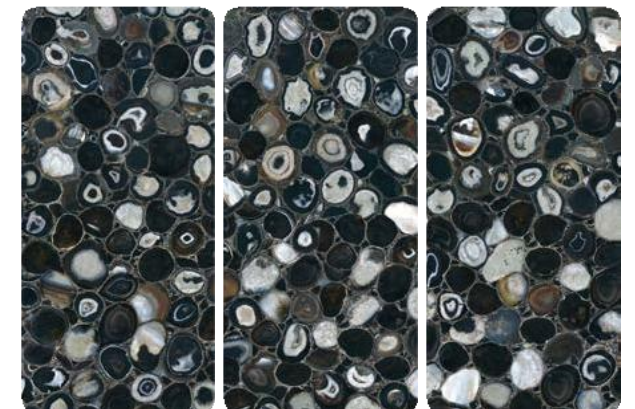
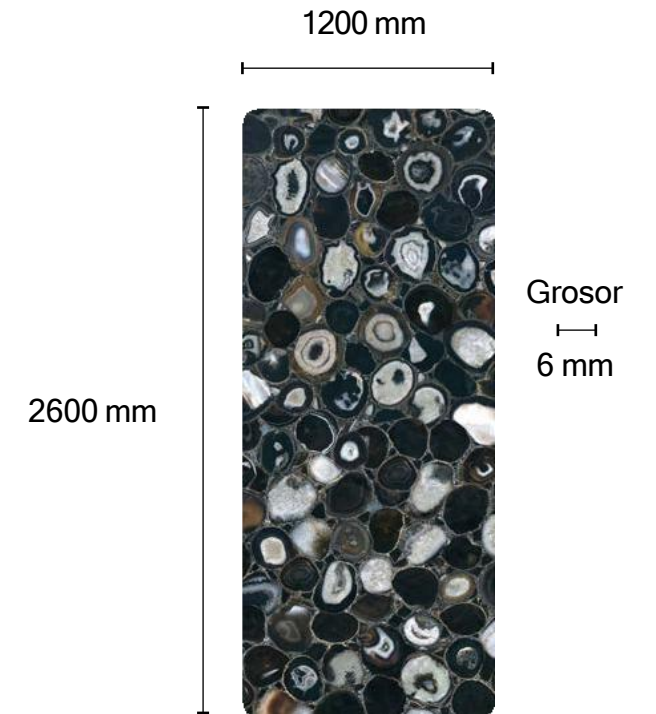

Acabado: **Pulido**

Secuencia Facial: **A B C**

Blue Onix

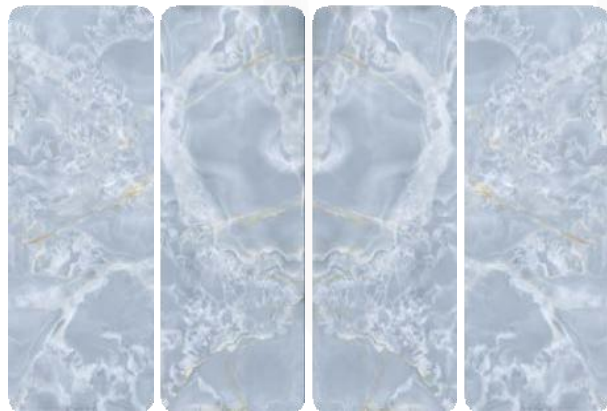
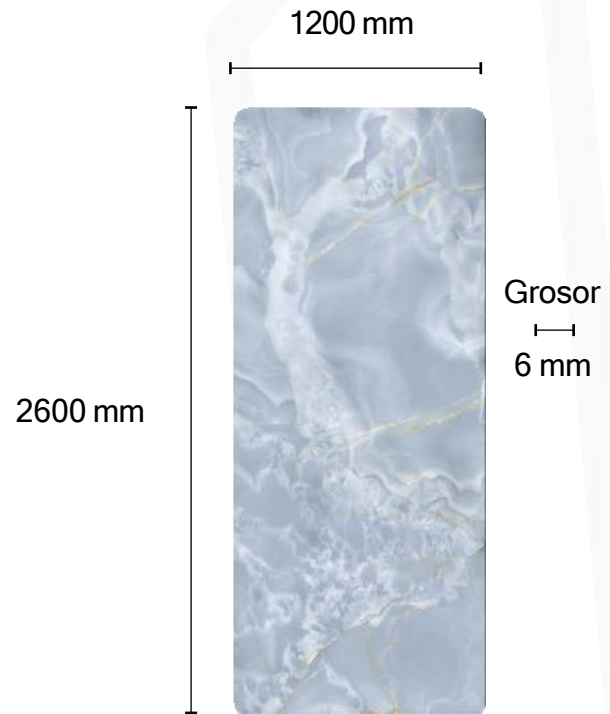

Acabado:

Pulido

Secuencia Facial:

A B C D

Bulgaria Medium Grey

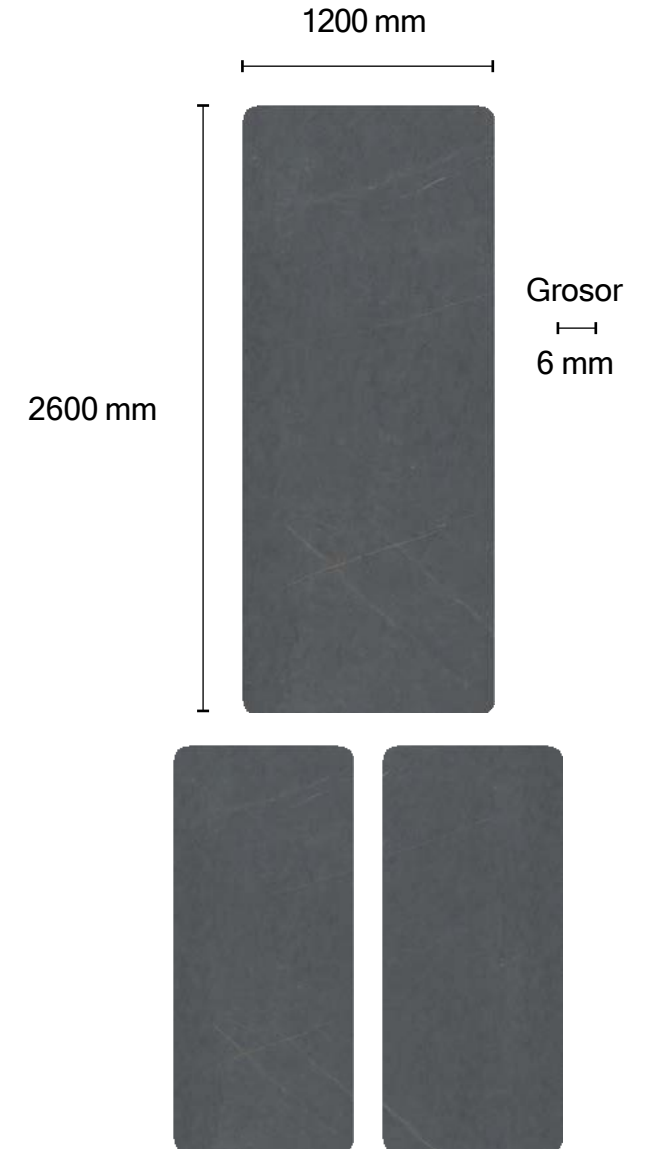

Acabado: **Mate**

Secuencia Facial: **A B**

Calacatta Bianco

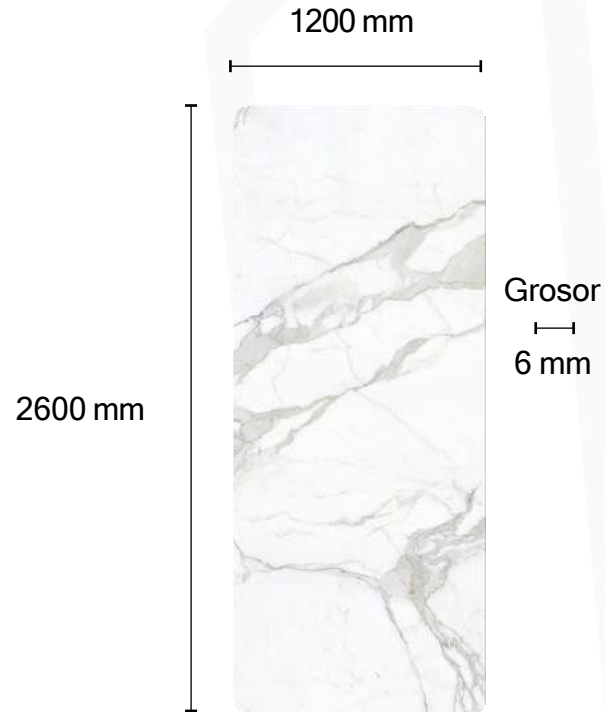

Acabado: **Mate**

Secuencia Facial: **A B C D**

Calacatta Extra

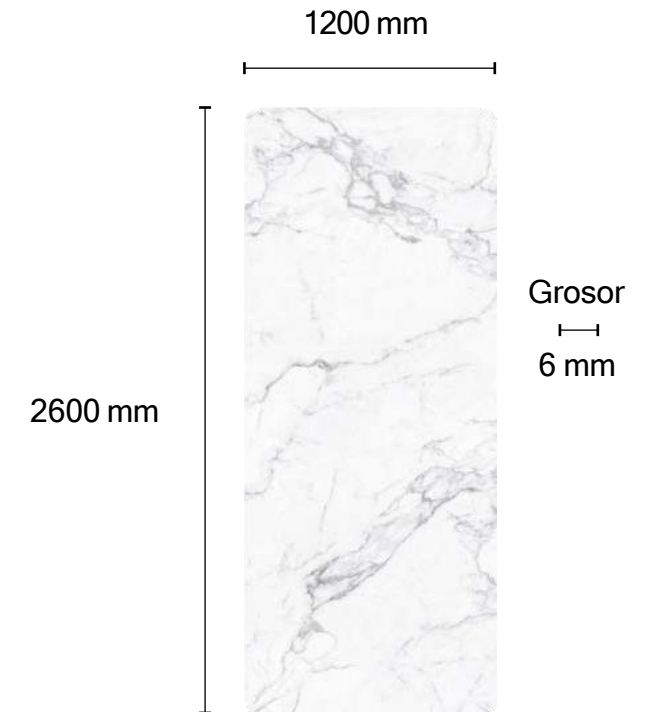

Acabado: **Pulido**

Secuencia Facial: **A B C**

Calacatta Gold Extra

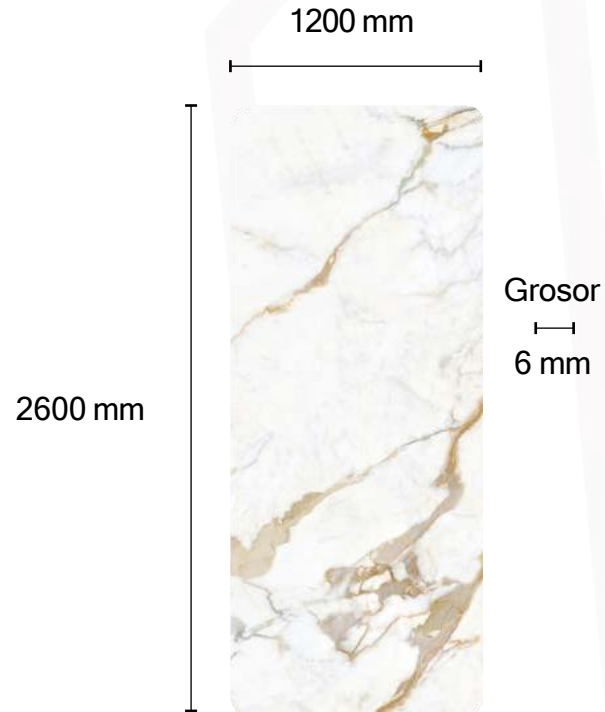

Acabado:

Mate

Secuencia Facial:

A B C

Calacatta Royal

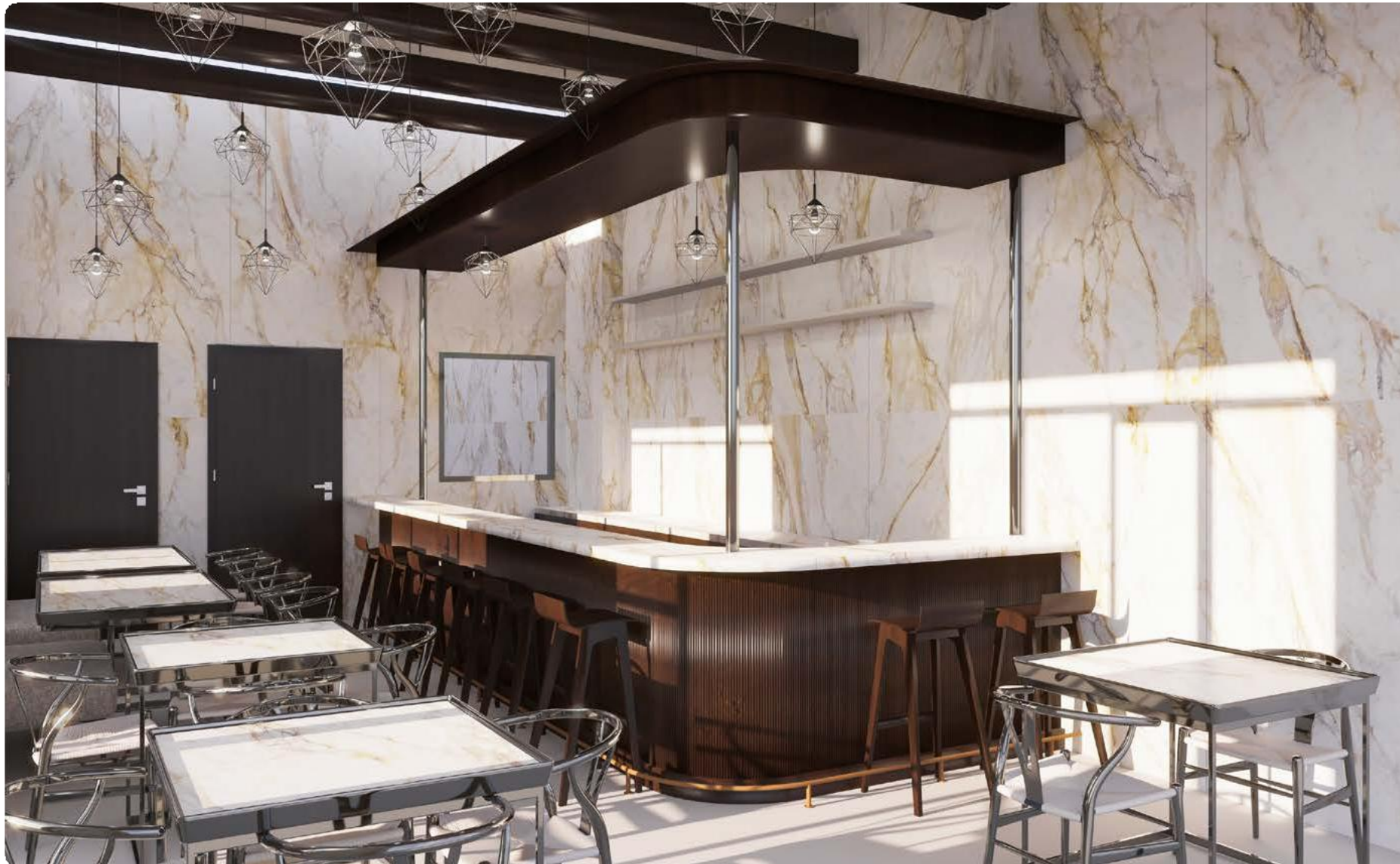

Acabado: **Mate**

Secuencia Facial: **A B C**

Calacatta White

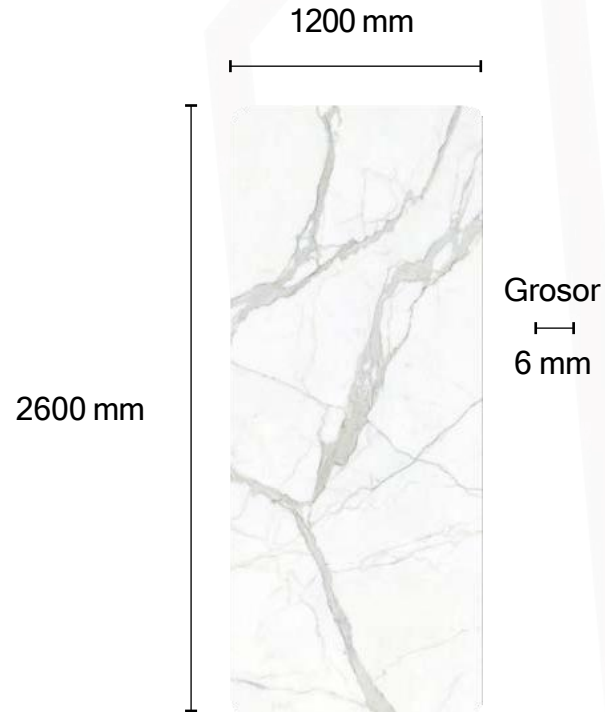

Acabado:

Mate / Pulido

Secuencia Facial:

A B C D

Cloisonne

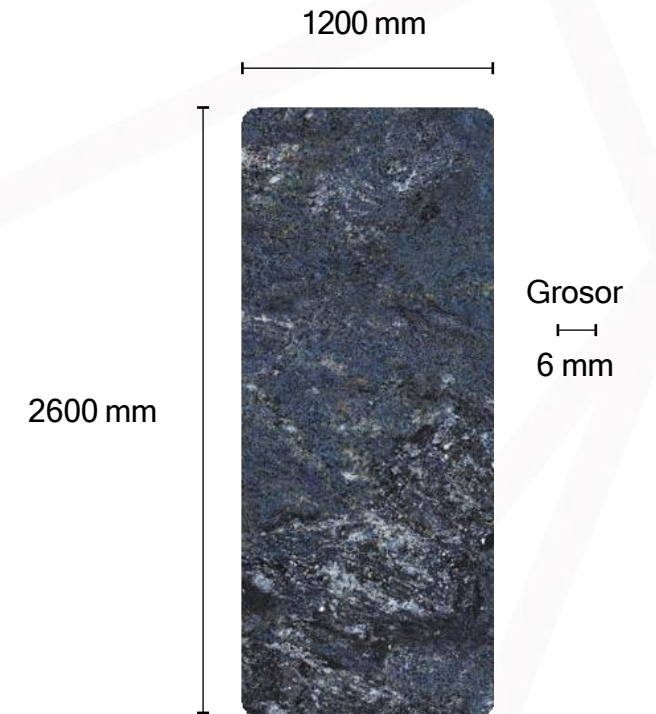

Acabado: **Pulido**

Secuencia Facial: **A B C**

Corten

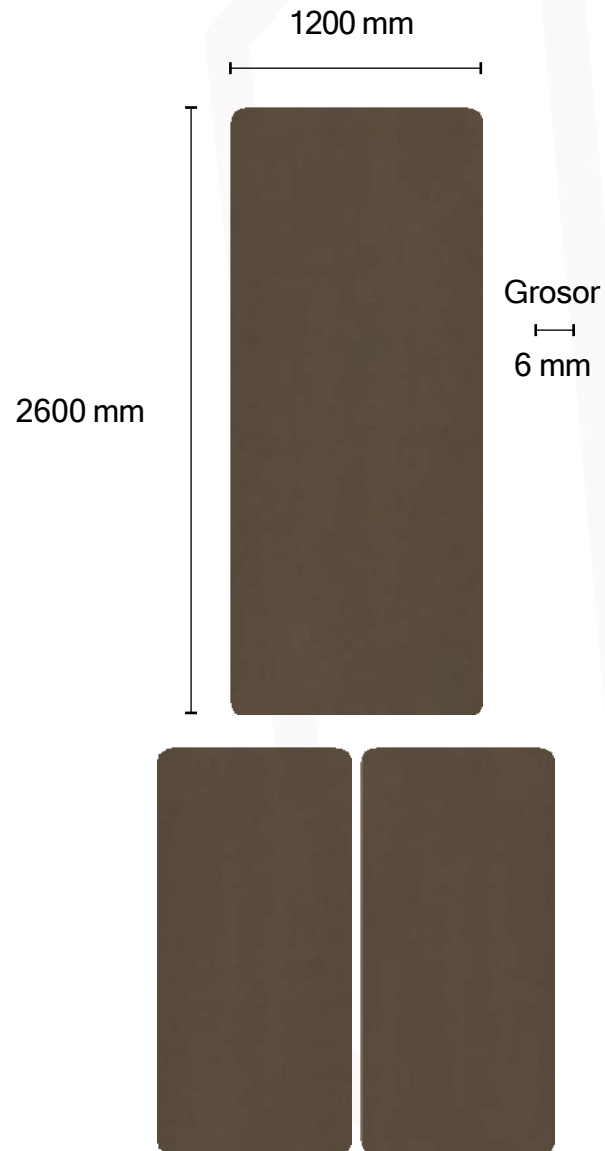

Acabado:

Mate

Secuencia Facial:

A B

Freezing Emerald

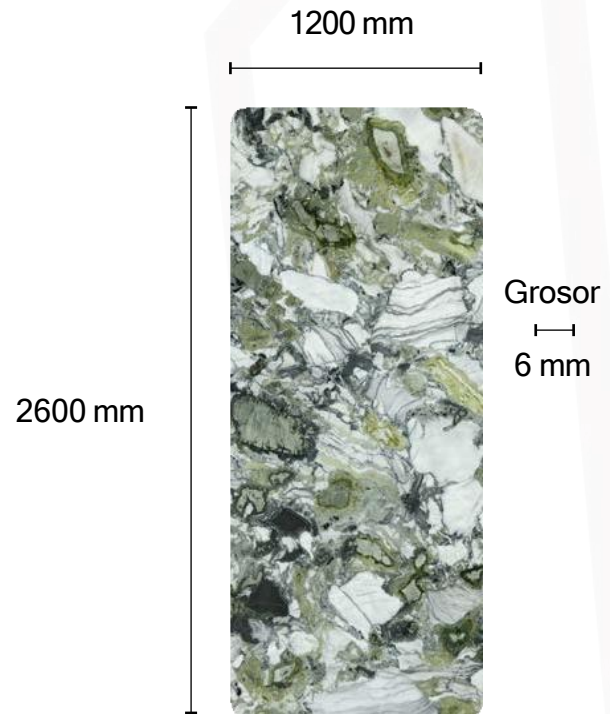

Acabado:

Pulido

Secuencia Facial:

A B C

Frozen Fox

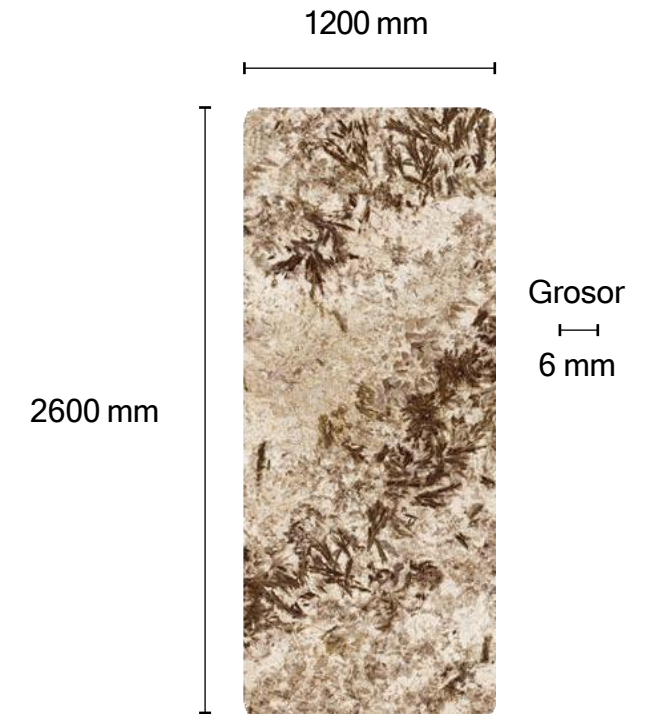

Acabado: **Pulido**

Secuencia Facial: **A B C**

Galaxy Black

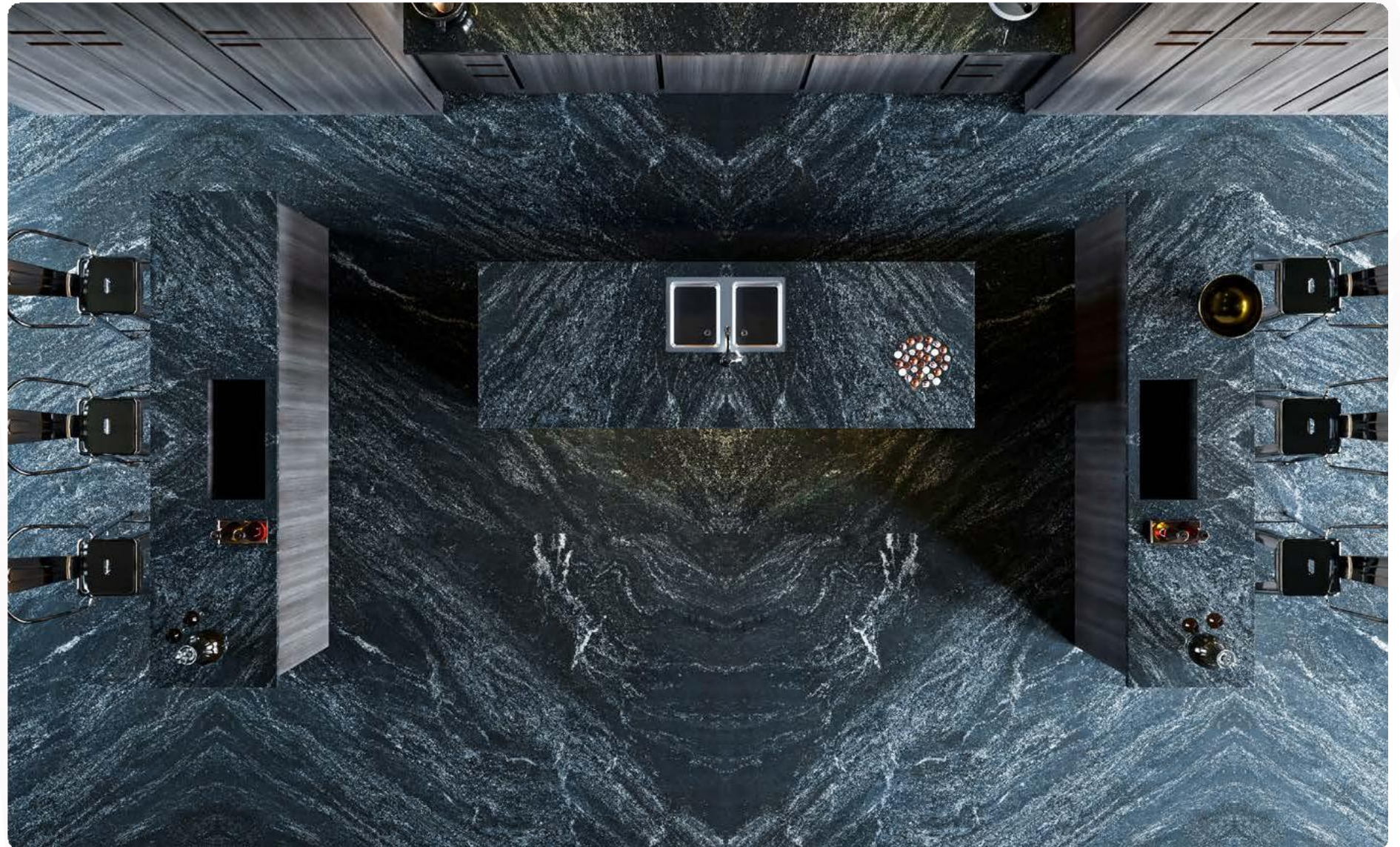
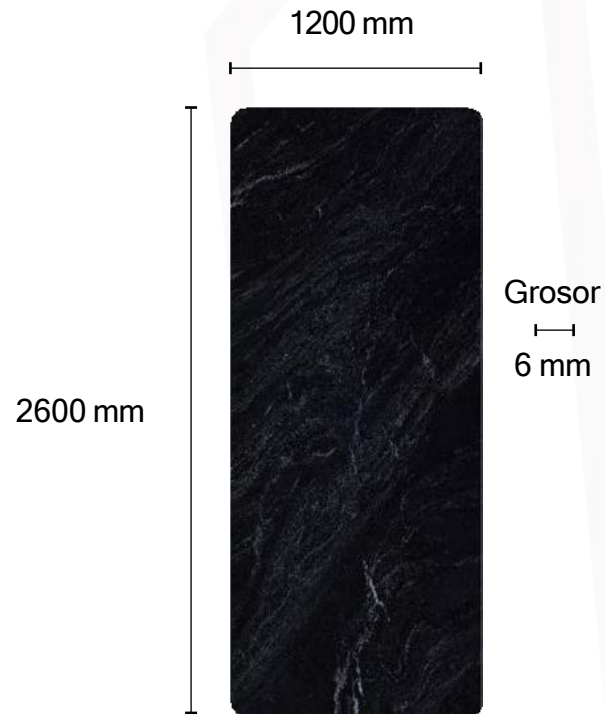

Acabado:

Pulido

Secuencia Facial:

A B

Iceberg Onix

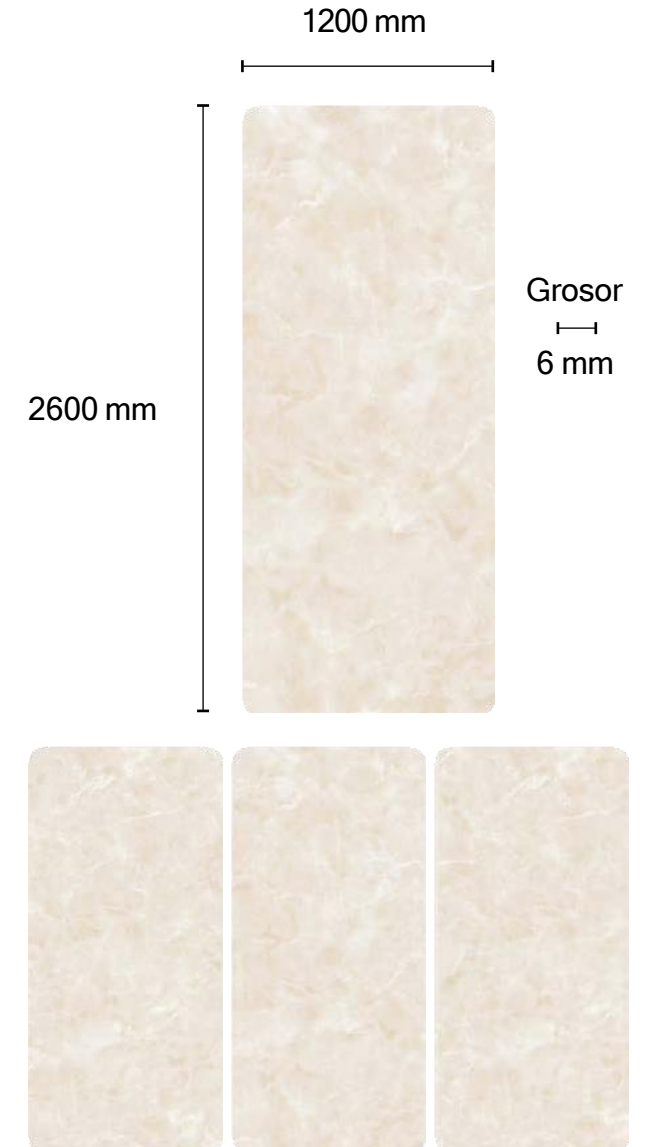

Acabado: **Pulido**

Secuencia Facial: **A B C**

Iron Copper

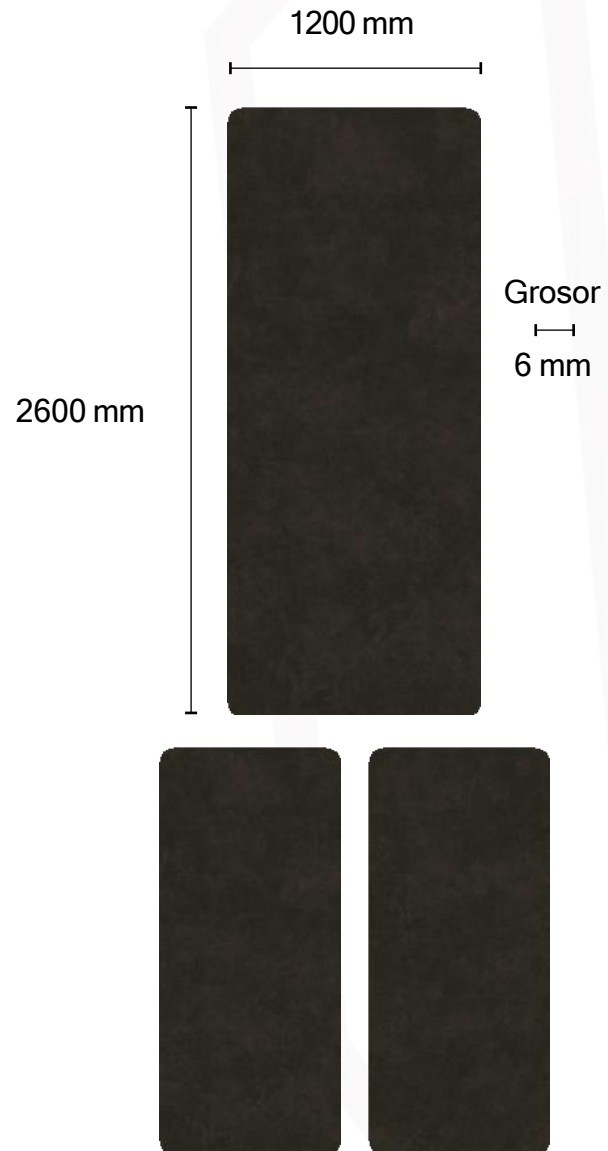

Acabado:

Mate

Secuencia Facial:

A B

Palissandro Blue



Acabado:

Pulido

Secuencia Facial:

A B C

Panda White

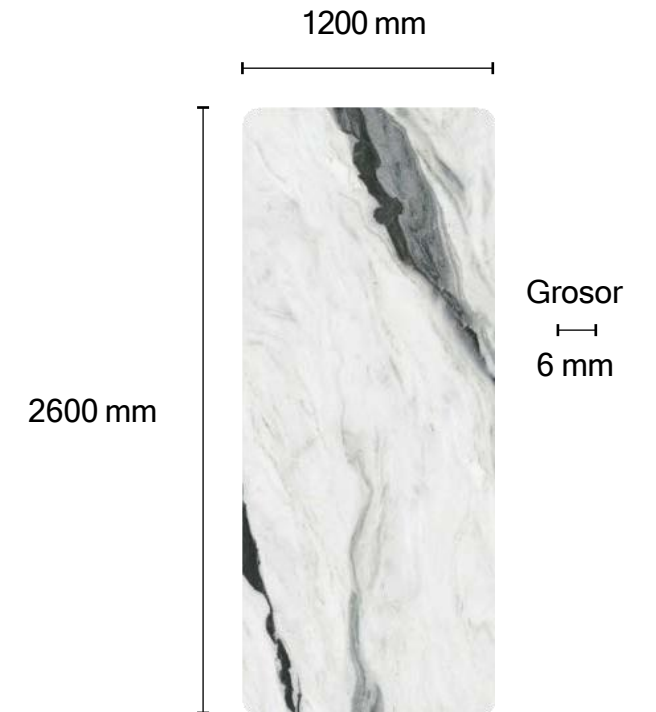

Acabado: **Pulido**

Secuencia Facial: **A B C D**

Platinum Leica



Acabado: Pulido / Mate

Secuencia Facial: A B C

Red Mansions

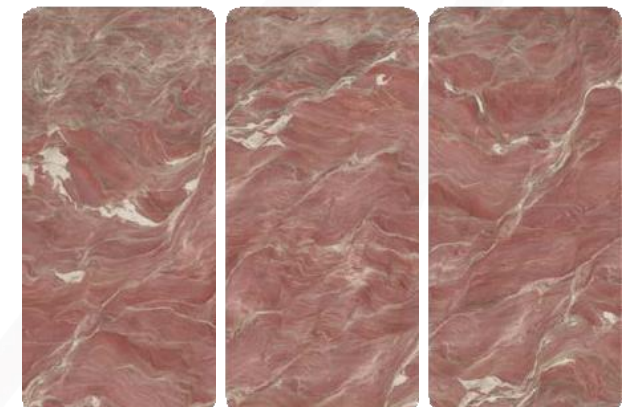
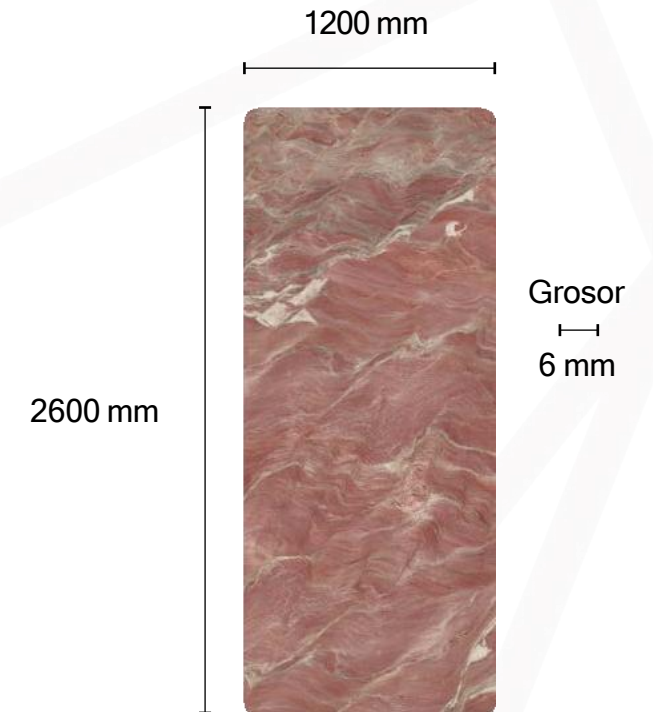

Acabado: **Pulido**

Secuencia Facial: **A B C**

ROMAN ONYX

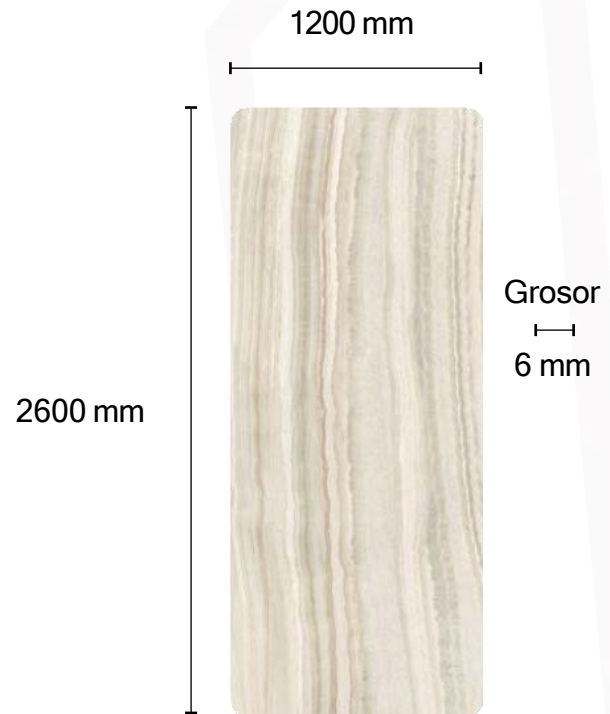

Acabado:

Pulido

Secuencia Facial:

A B C

Sandy Grey Cream

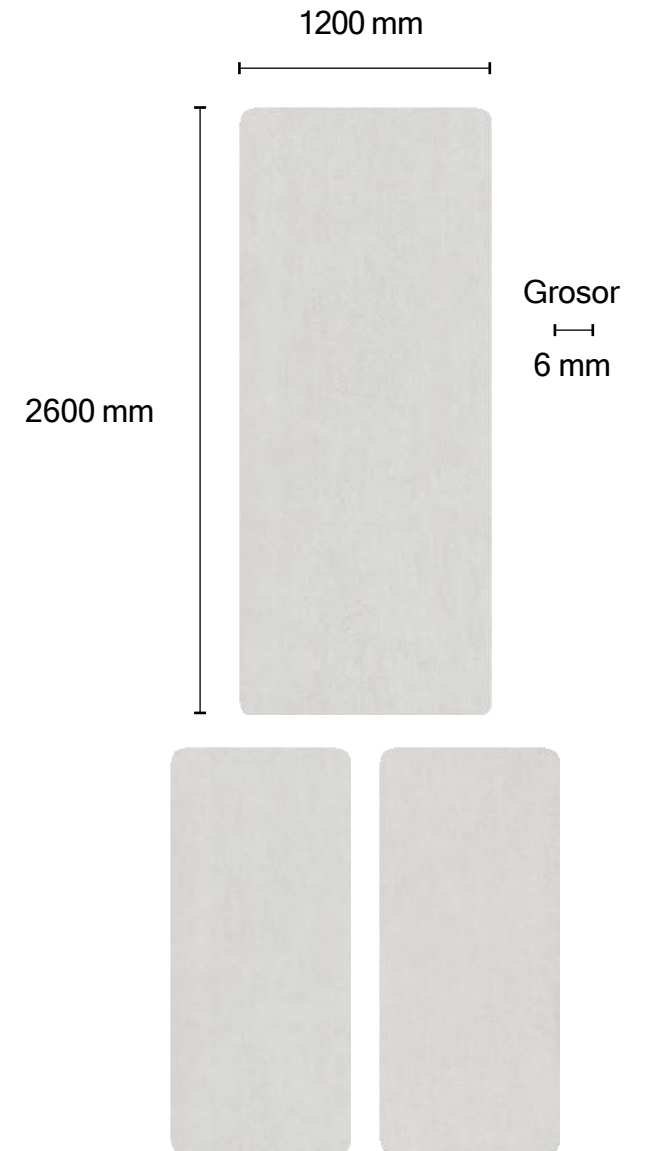

Acabado: **Mate**

Secuencia Facial: **A B**

Statuario Venato

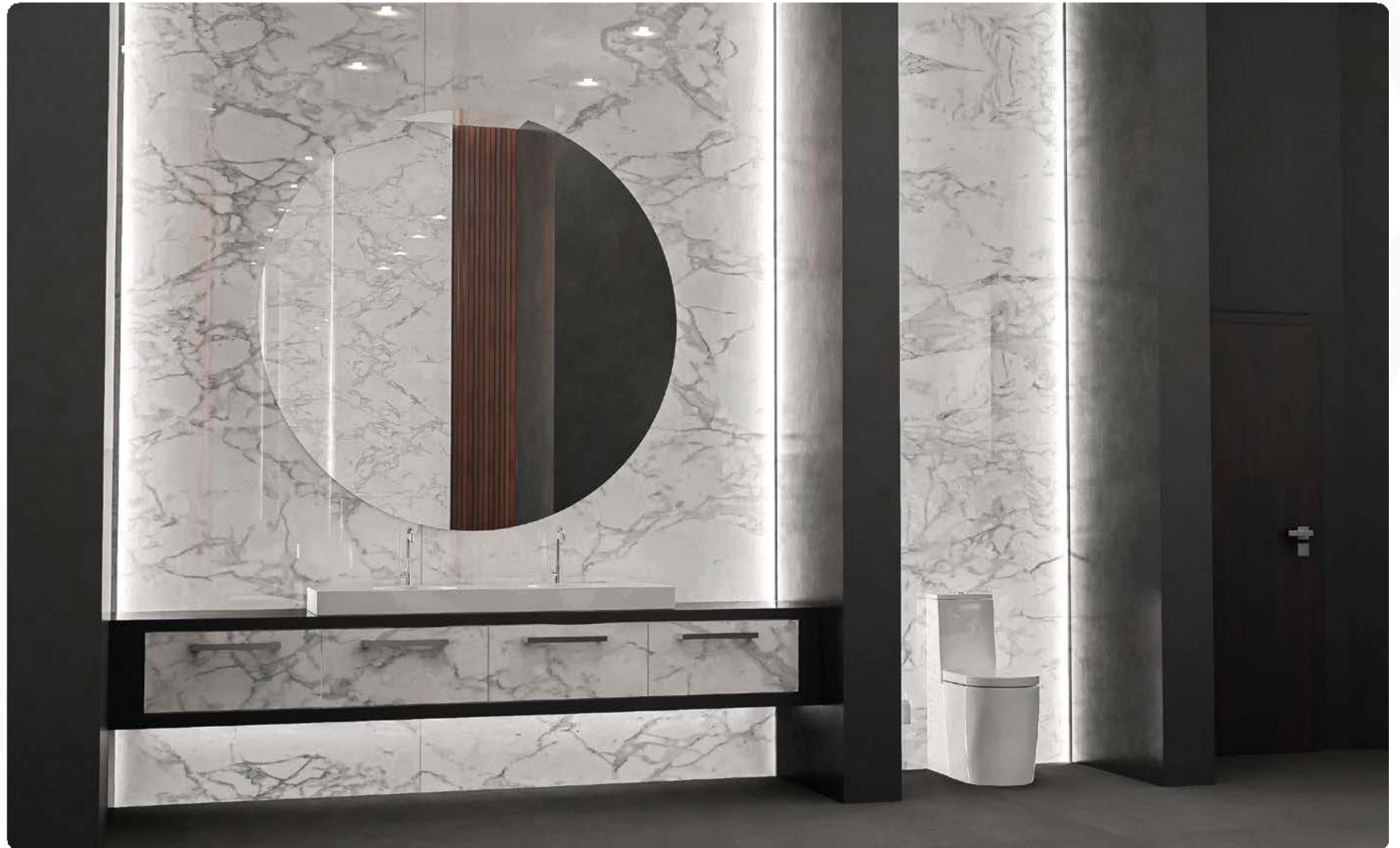
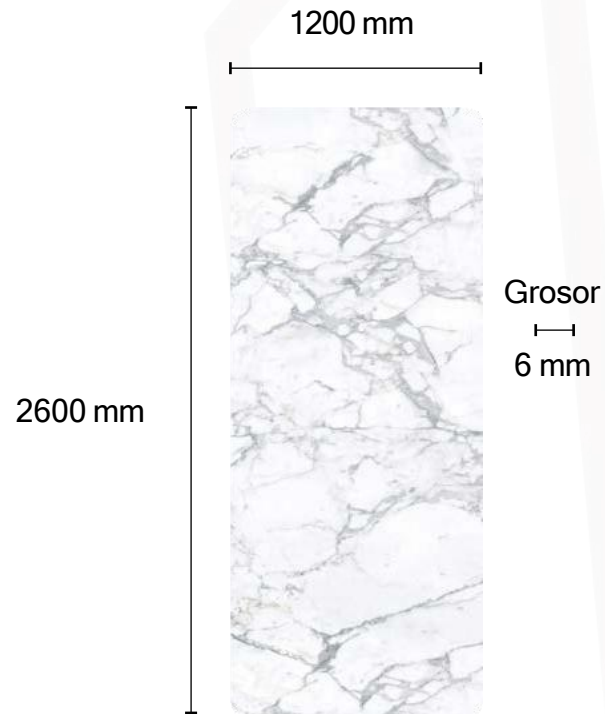

Acabado:

Pulido

Secuencia Facial:

A B

Statuario White

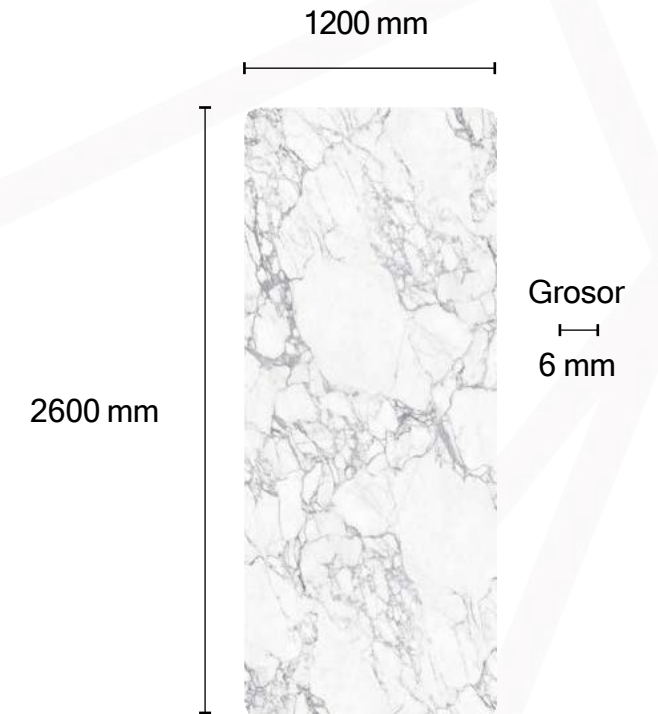

Acabado: **Mate**

Secuencia Facial: **A B C**

White

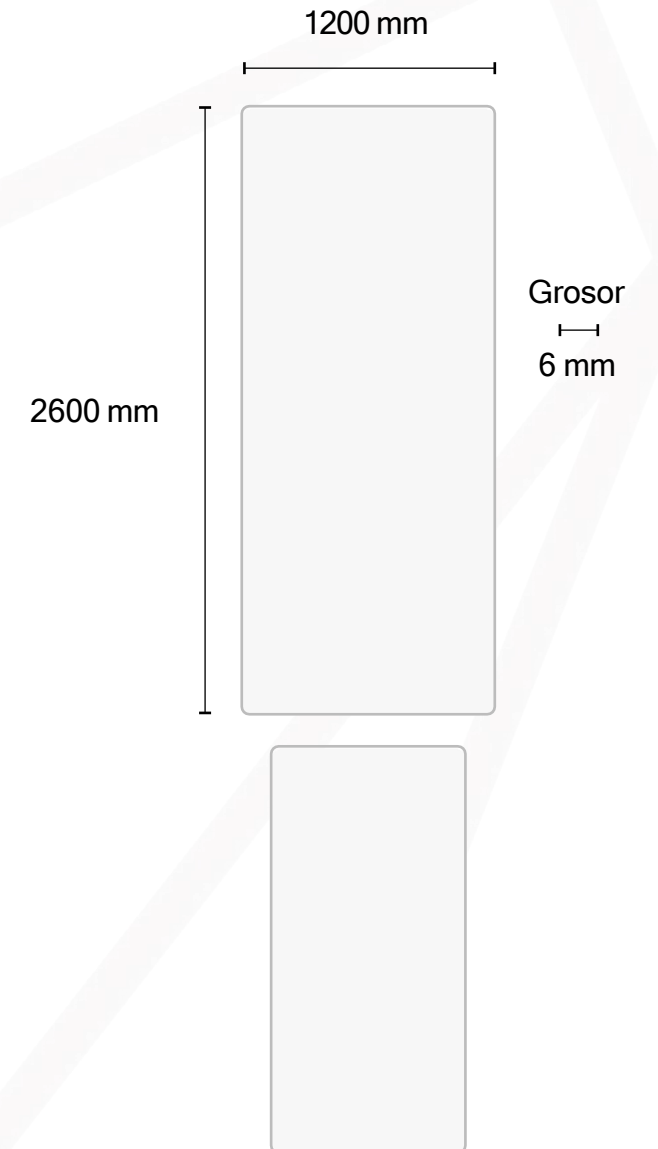

Acabado: **Mate**

Secuencia Facial: **U**

1200 x 2700 x 6MM

**PIEDRA TECNOLÓGICA /
LOSA SINTERIZADA**

BLUE AGATE

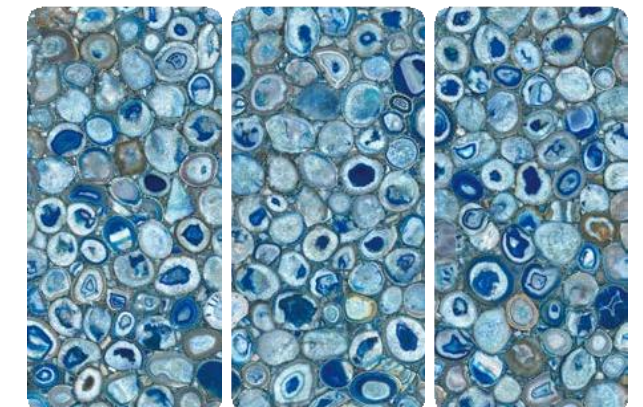
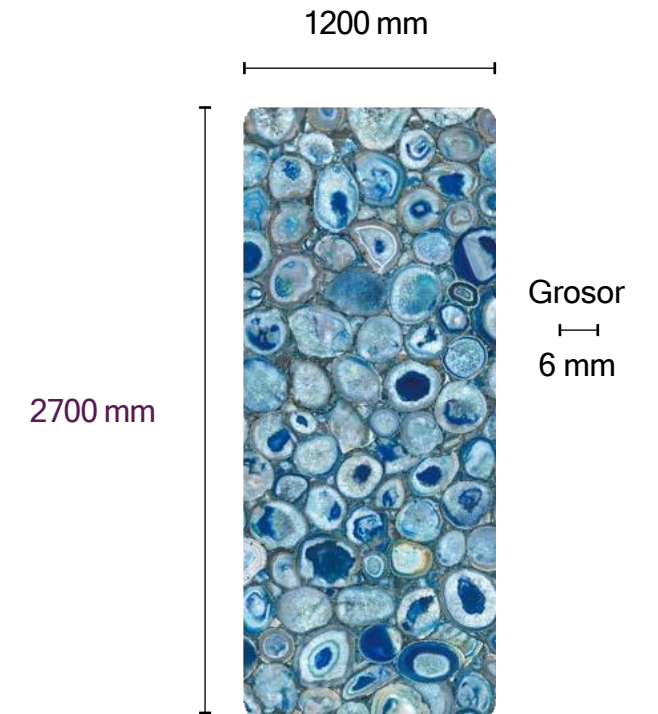

Acabado: **Pulido**

Secuencia Facial: **A B C**

Calacatta Gold



Acabado:

Pulido

Secuencia Facial:

A B C

Frapuccino

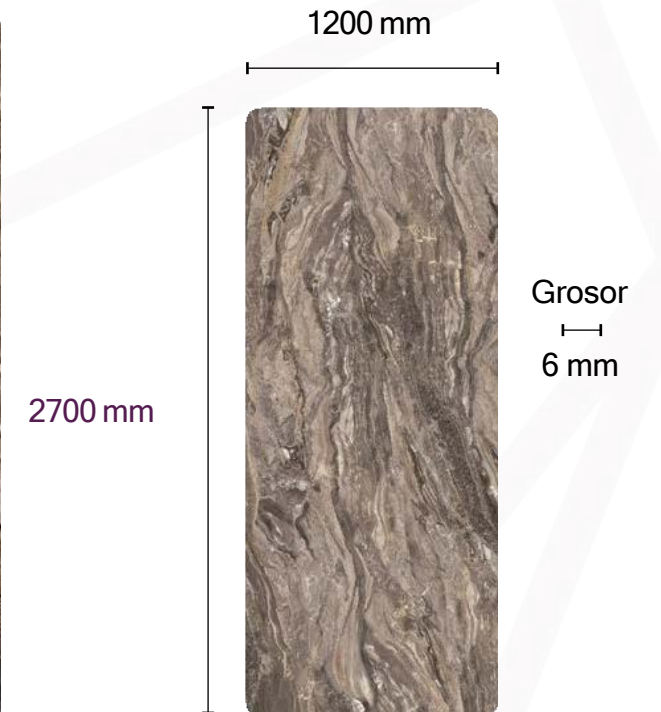

Acabado: **Pulido**

Secuencia Facial: **A B C**



1600 x 3200 x 6 MM

**PIEDRA TECNOLÓGICA /
LOSA SINTERIZADA**

Placa: Panda White

Amazon Green

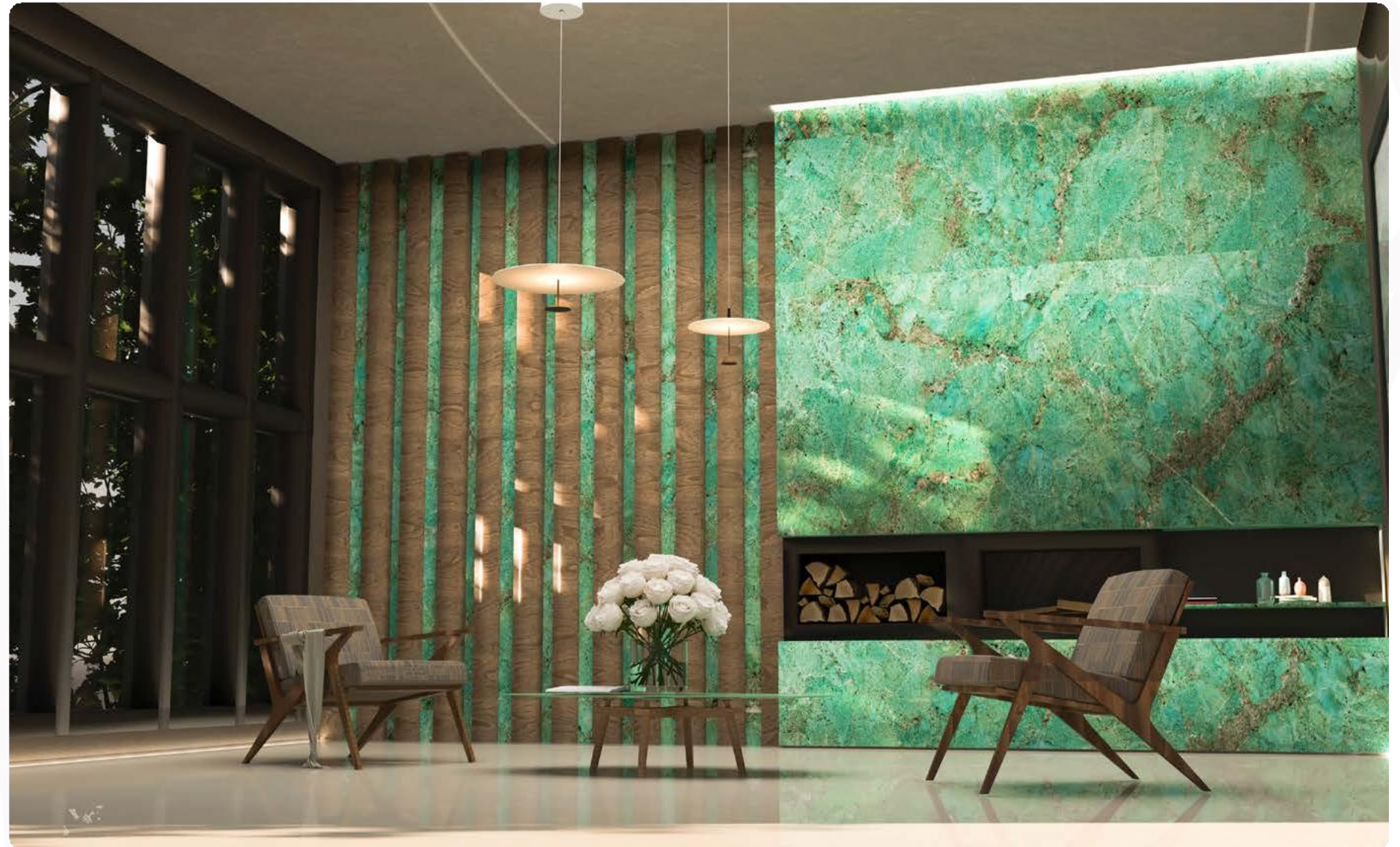
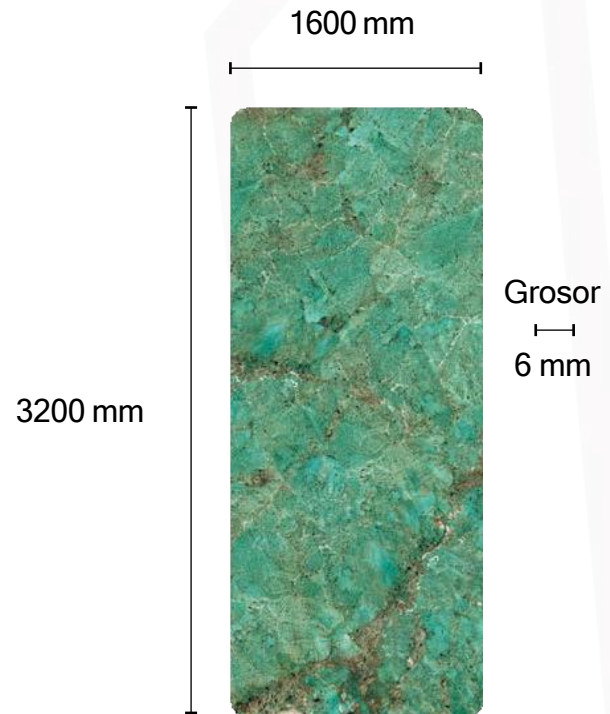

Acabado:

Pulido

Secuencia Facial:

A B C

Ariston White



Acabado: **Pulido**

Secuencia Facial: **A B C**

Calacatta White



Acabado:

Pulido

Secuencia Facial:

A B C

Cartier Gold

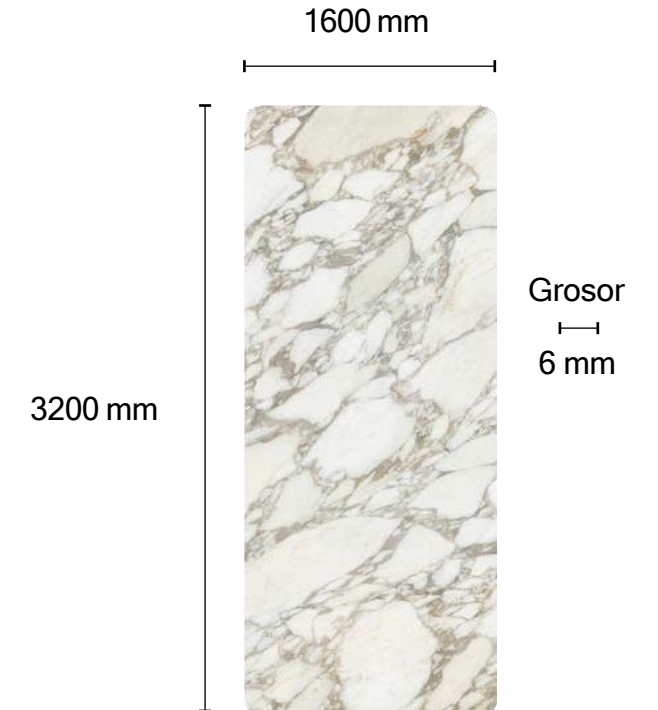

Acabado: **Pulido Suave**

Secuencia Facial: **A B C**

Corten

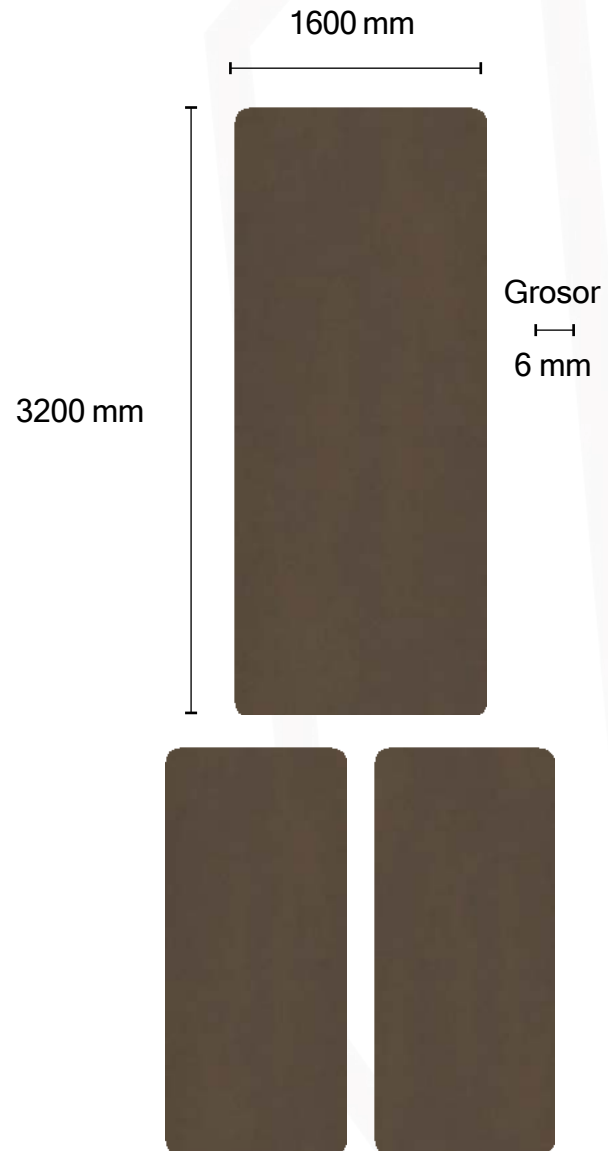

Acabado:

Mate

Secuencia Facial:

A B

Freezing Emerald

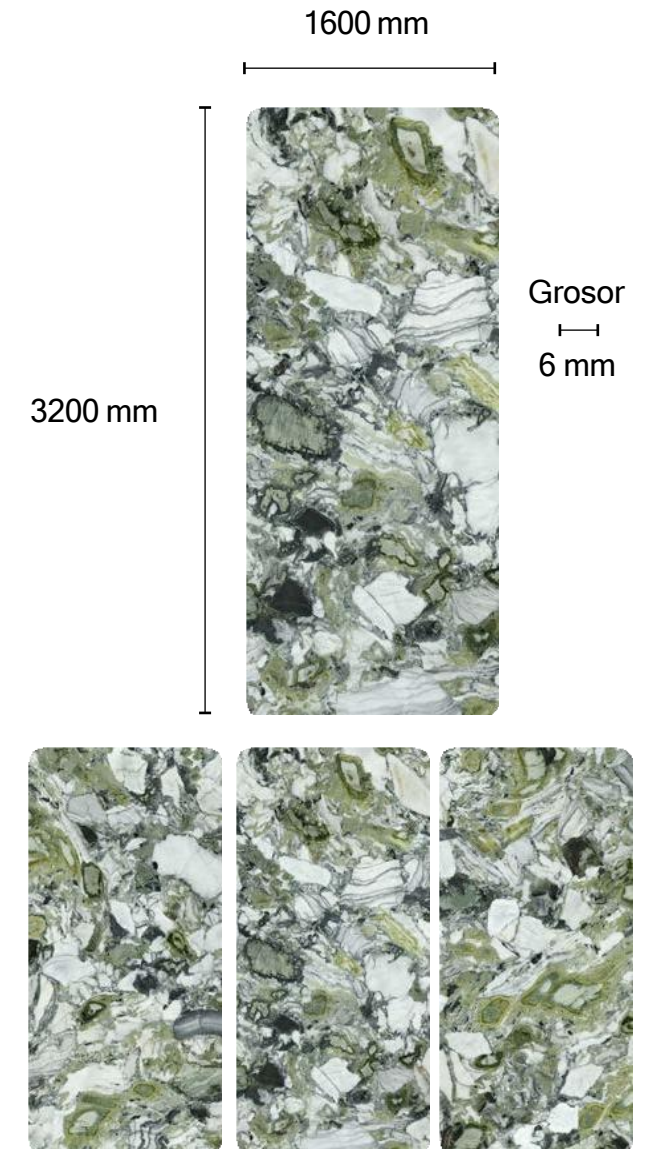

Acabado: **Pulido**

Secuencia Facial: **A B C**

Galaxy Black



Acabado:

Mate / Pulido

Secuencia Facial:

A B

Iron Copper

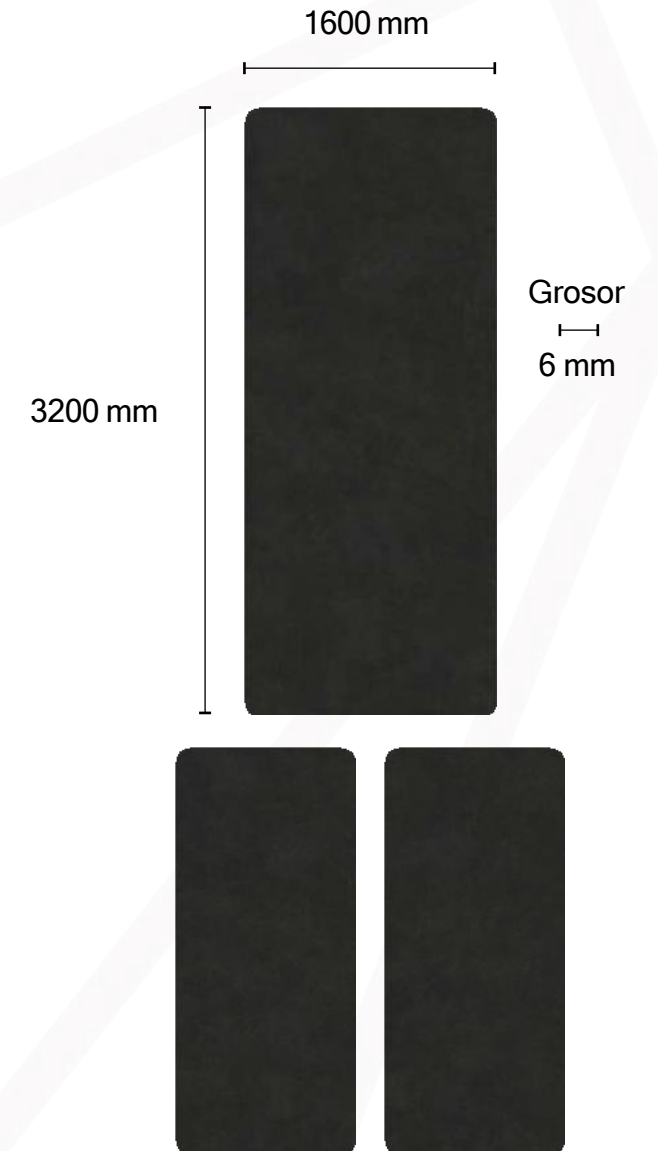

Acabado: **Mate**

Secuencia Facial: **A B**

Latte

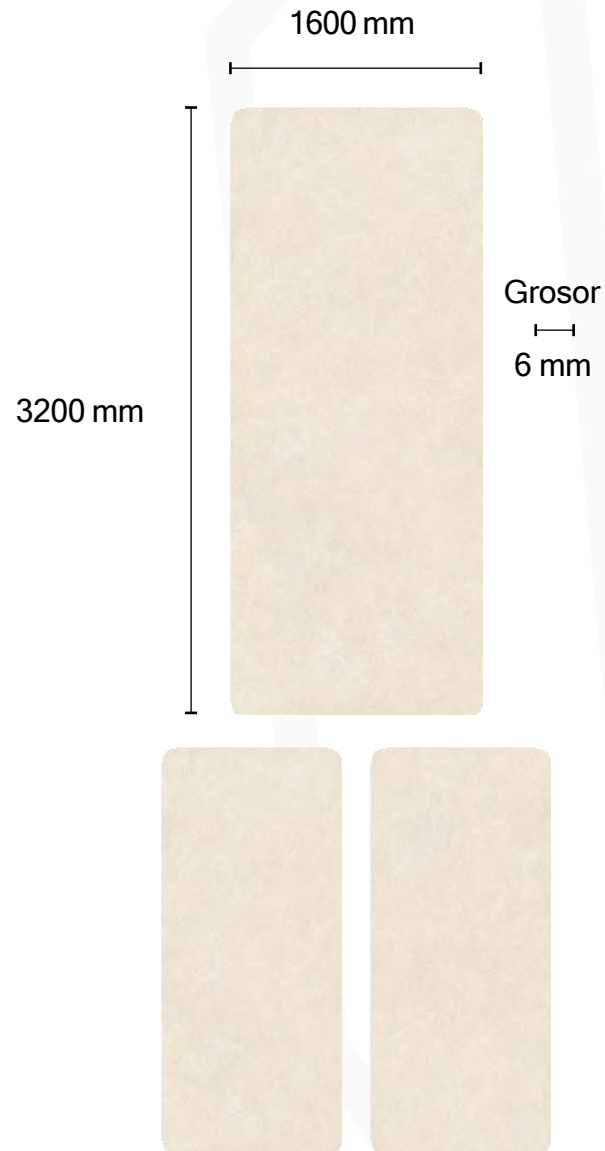

Acabado: **Pulido**

Secuencia Facial: **A B**

Latte Ash

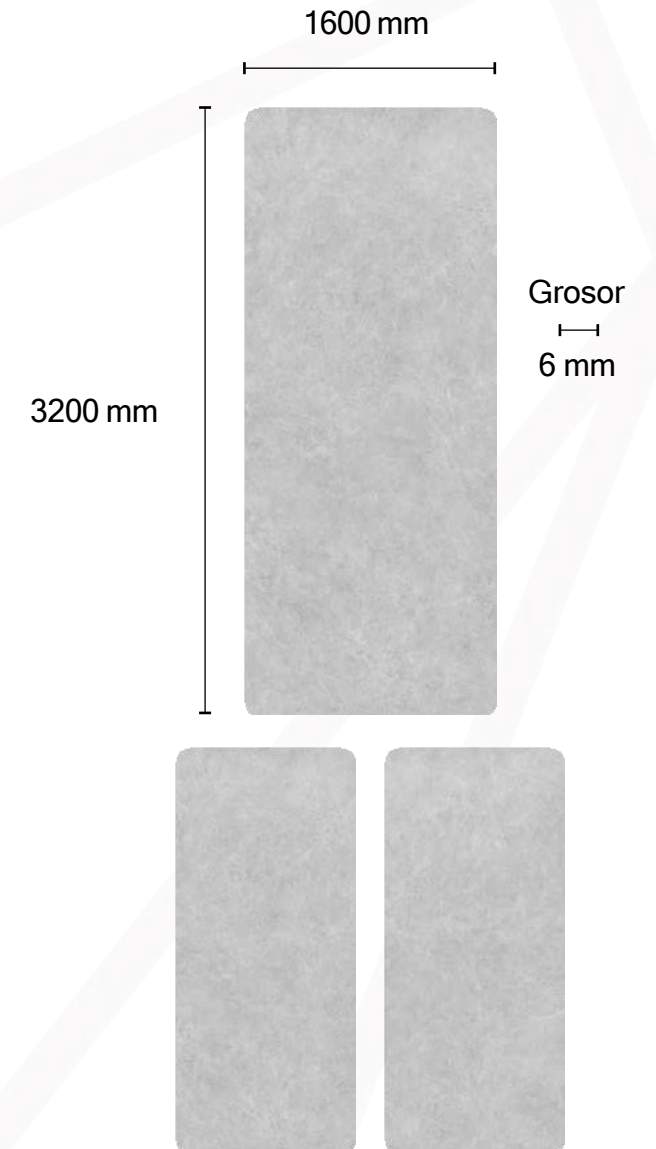

Acabado: **Pulido**

Secuencia Facial: **A B**

Panda White

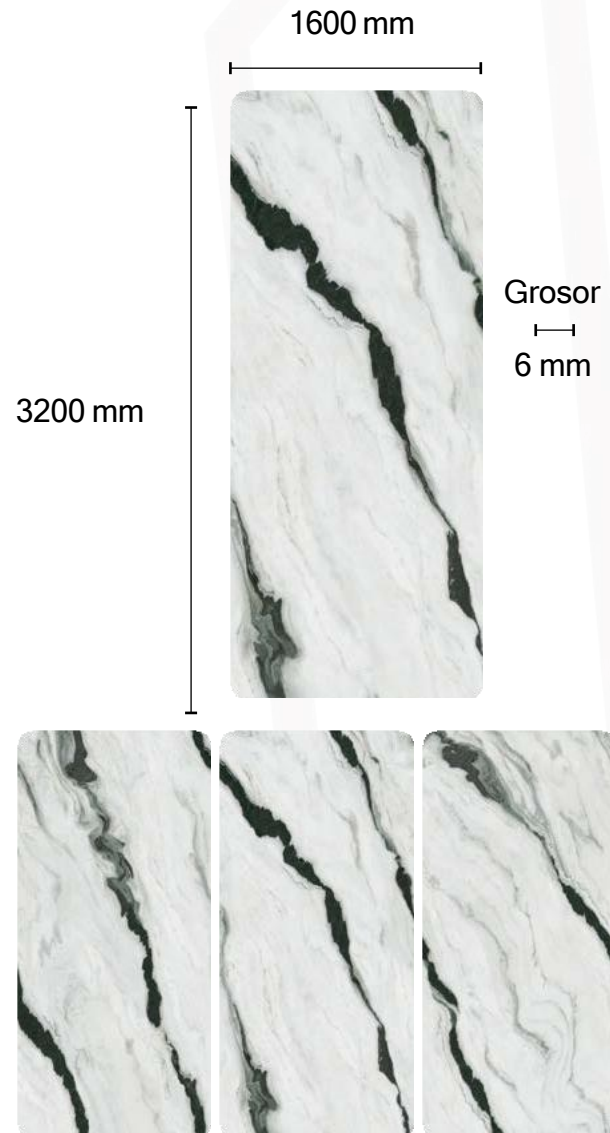

Acabado: **Pulido**

Secuencia Facial: **A B C**

Platinum Leica



Acabado: **Pulido Suave**

Secuencia Facial: **A B C**

Prada Green

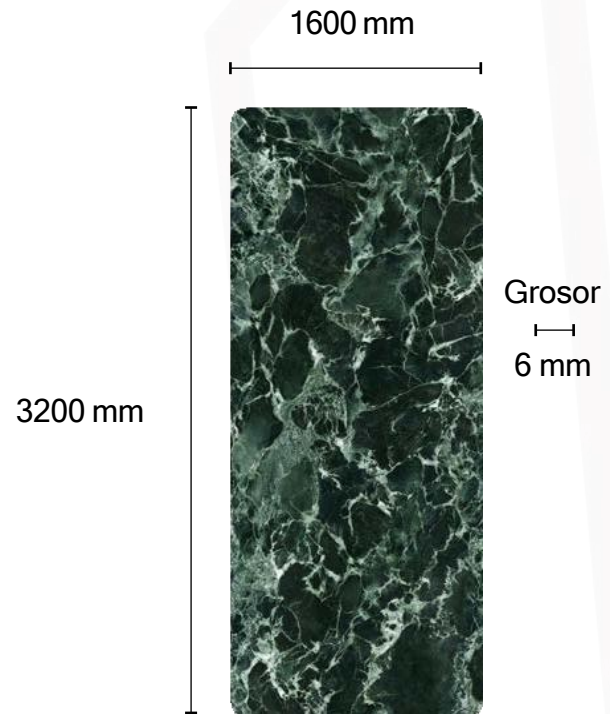

Acabado:

Pulido

Secuencia Facial:

A B C

Sandy Grey Light

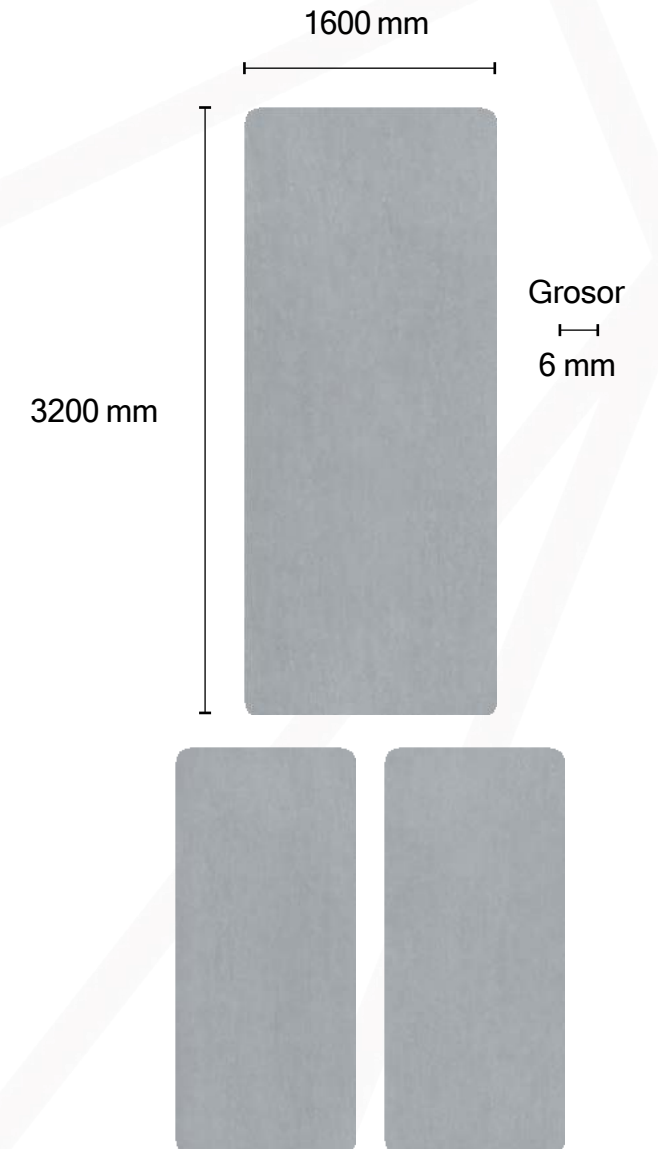

Acabado: **Mate**

Secuencia Facial: **A B**

Sandy Grey Media

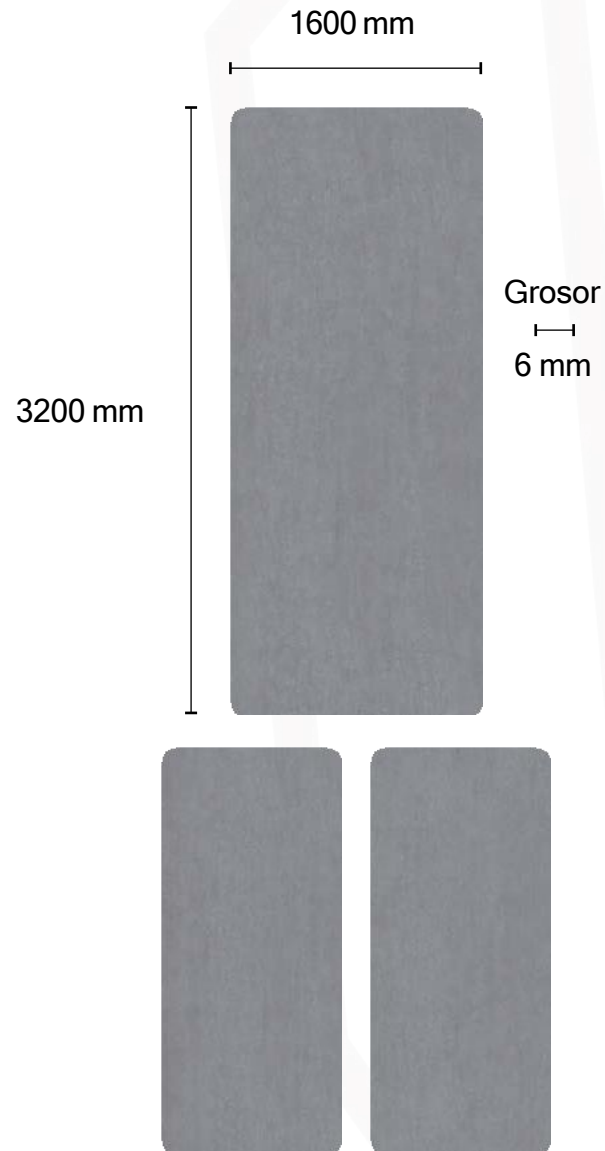

Acabado: **Mate**

Secuencia Facial: **A B**

Van Gogh Grey

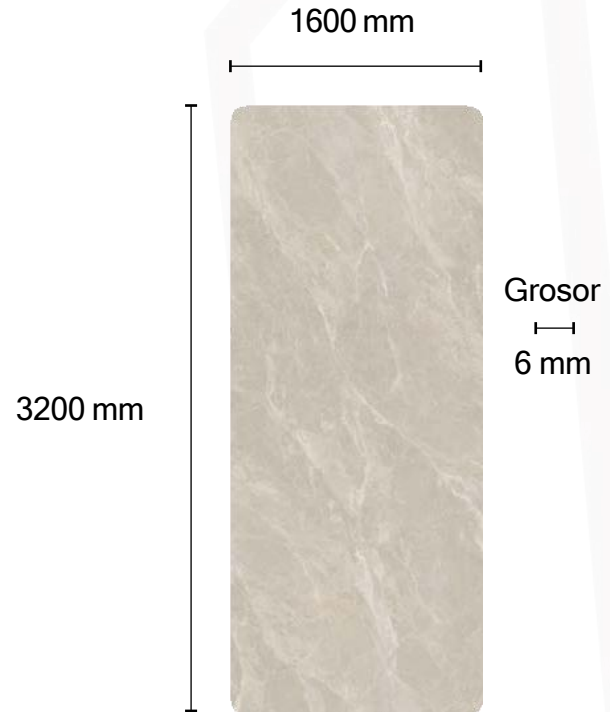

Acabado: **Pulido Suave**

Secuencia Facial: **A B C**

White

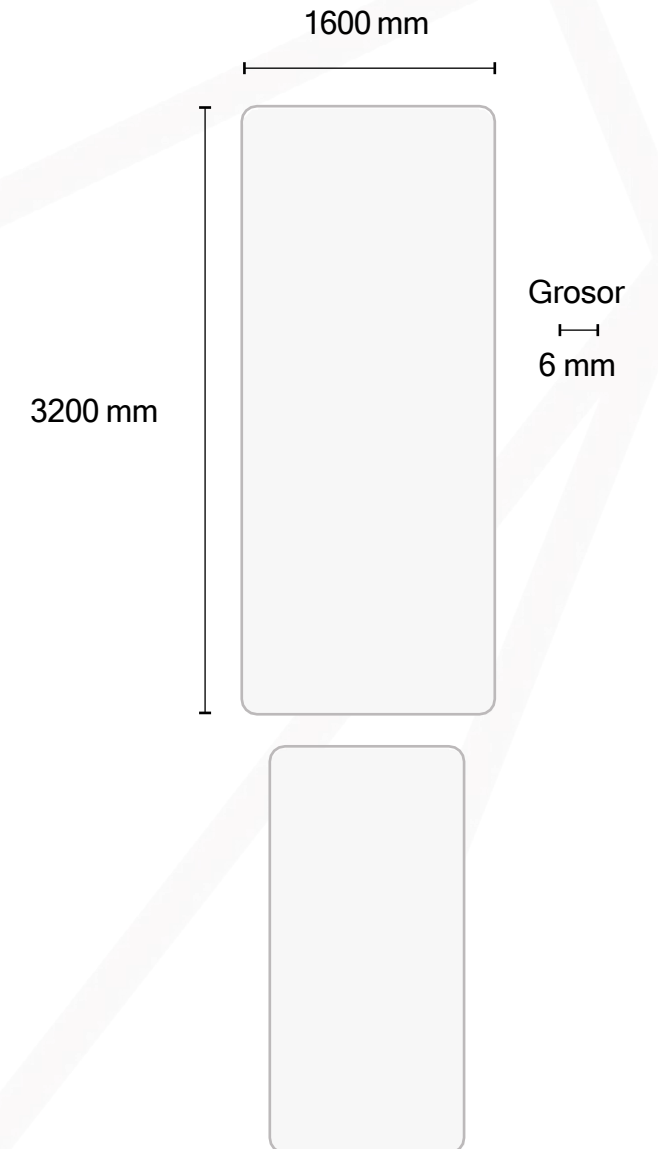

Acabado: **Mate**

Secuencia Facial: **U**



SINTERED[®]
S T O N E

9MM

PIEDRA TECNOLÓGICA /
LOSA SINTERIZADA

1200 x 2400 x 9MM

PIEDRA TECNOLÓGICA /
LOSA SINTERIZADA

Ice Age

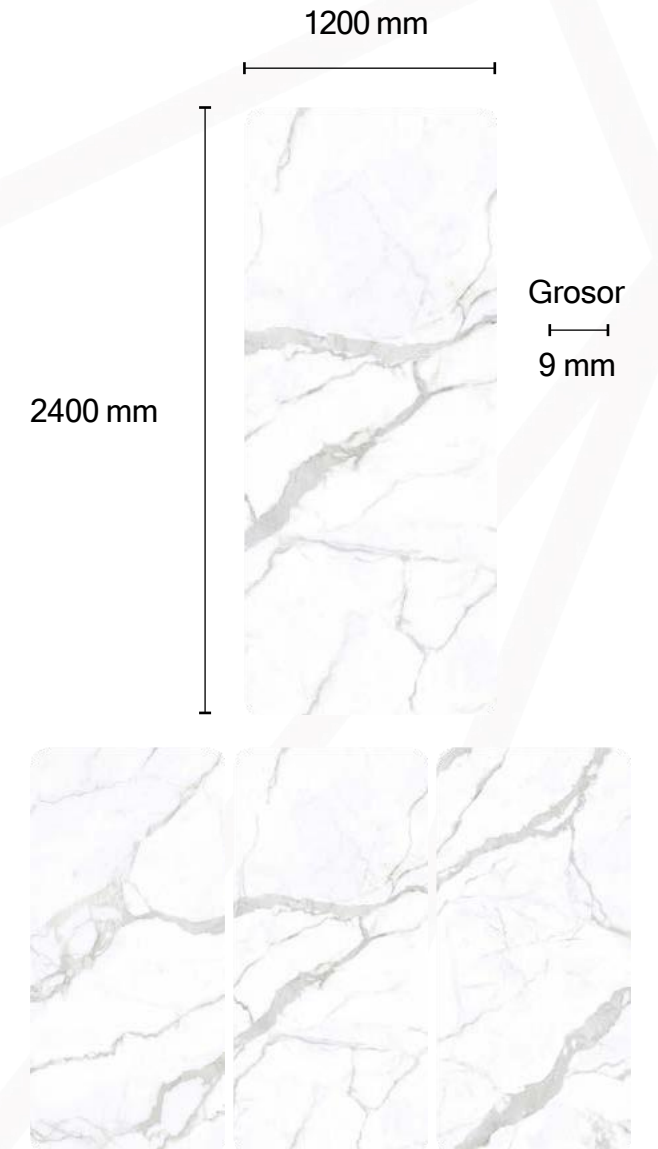

Acabado: **Pulido**

Secuencia Facial: **A B C**

Panda White

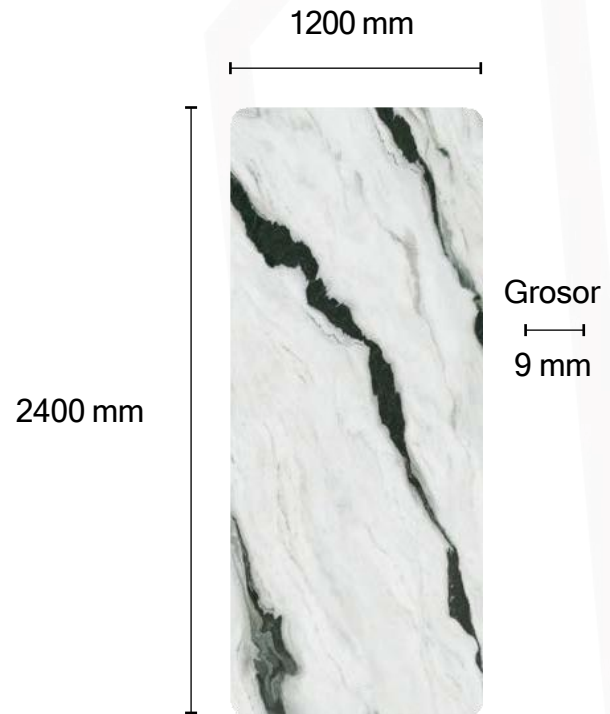

Acabado: **Pulido**

Secuencia Facial: **A B C**

Statuario Altissimo

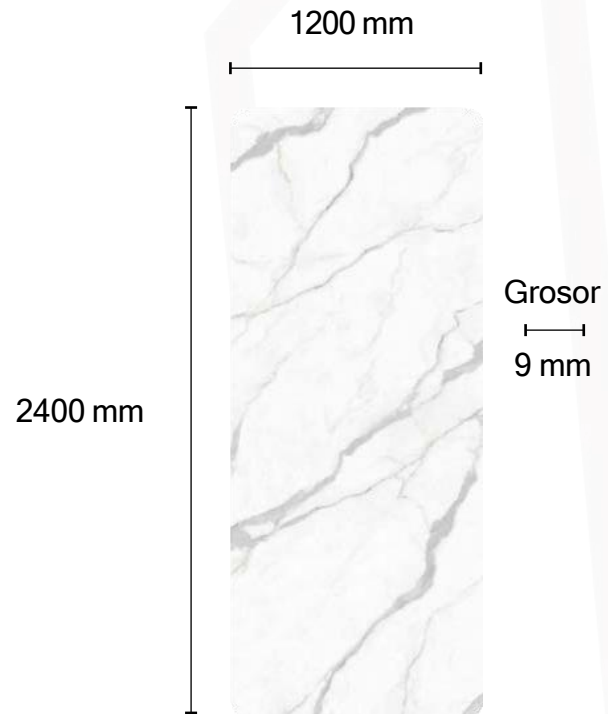

Acabado:

Pulido

Secuencia Facial:

A B C

Victoria White

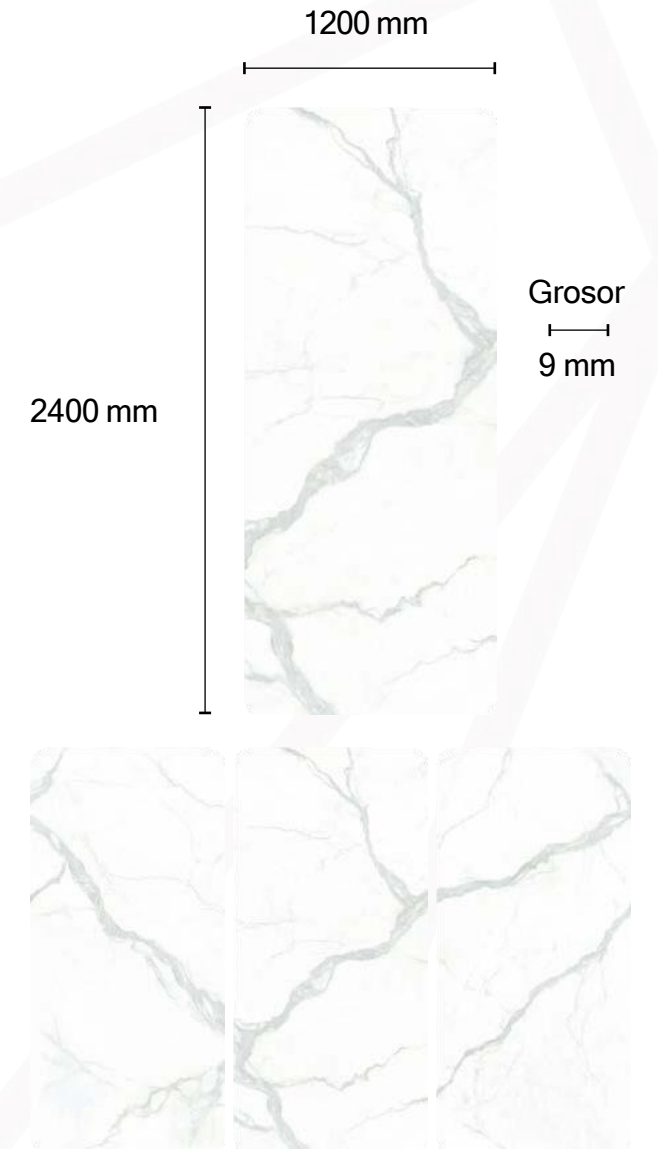

Acabado: **Pulido**

Secuencia Facial: **A B C**

Venus White

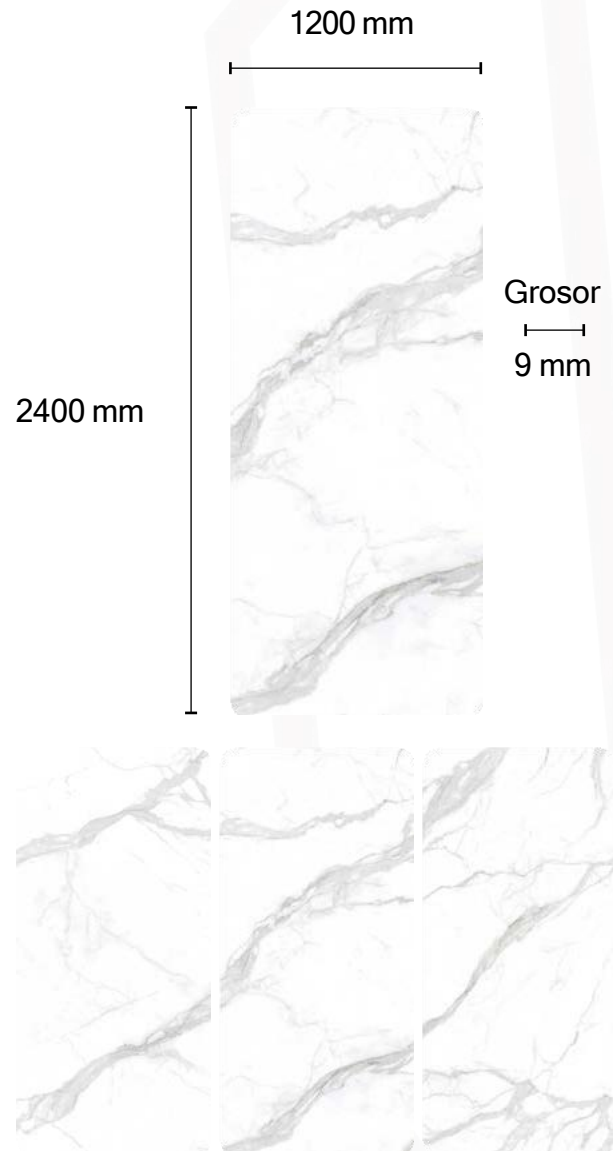

Acabado:

Pulido

Secuencia Facial:

A B C



1200 x 2600 x 9MM

PIEDRA TECNOLÓGICA /
LOSA SINTERIZADA

Calacatta White

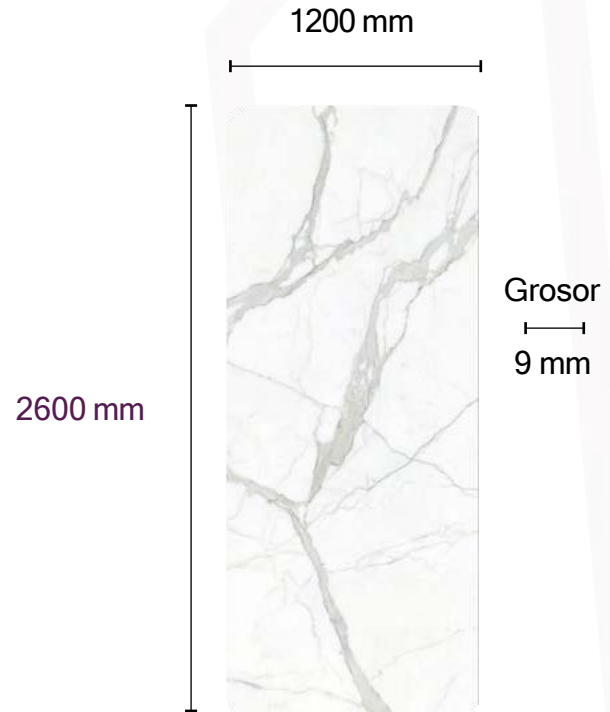

Acabado: **Pulido**

Secuencia Facial: **A B C D**

Red Mansions

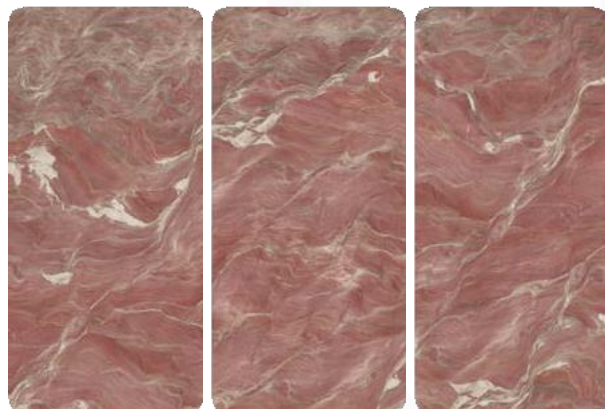
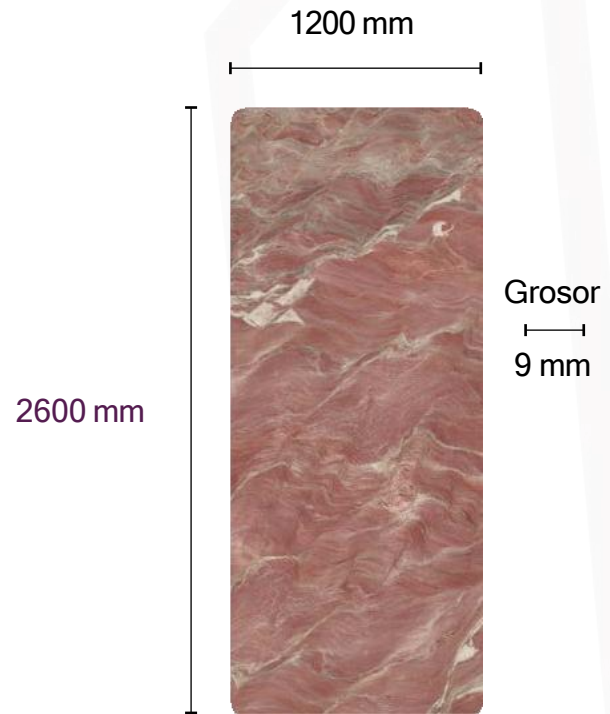

Acabado:

Pulido

Secuencia Facial:

A B C

Shangri-La

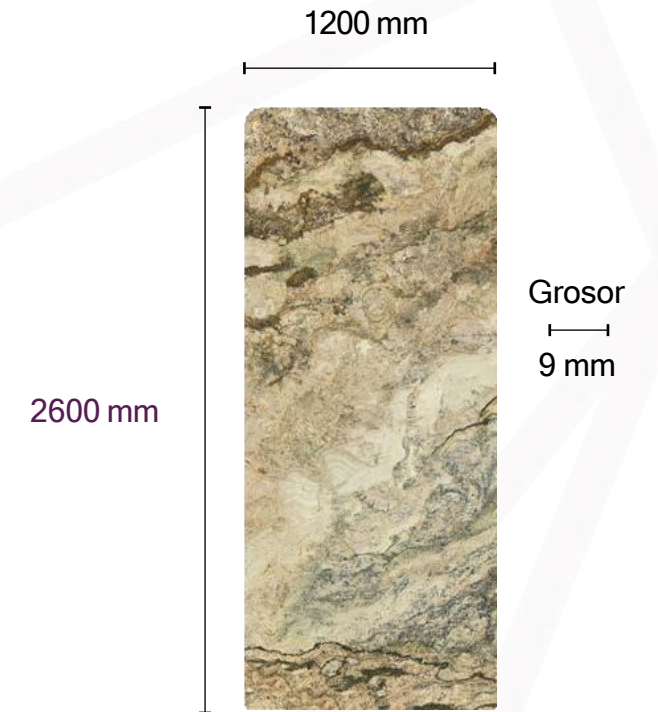

Acabado: **Pulido**

Secuencia Facial: **A B C**

Statuario White

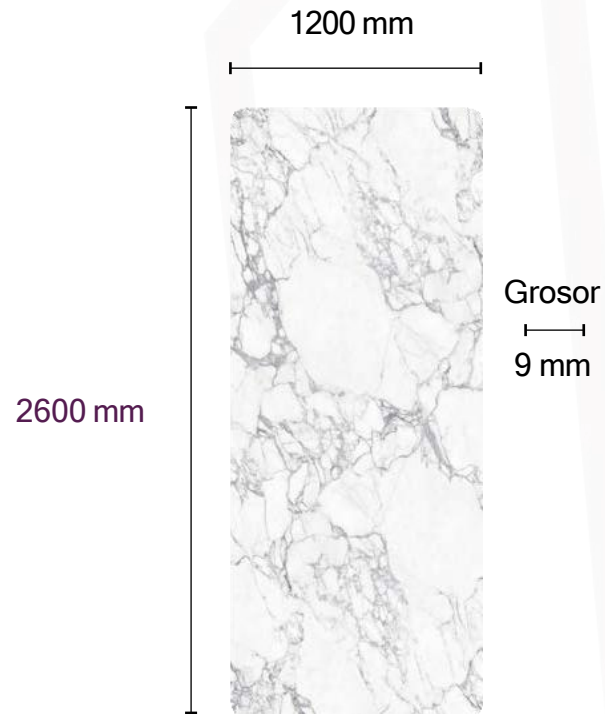

Acabado:

Pulido

Secuencia Facial:

A B C



SINTERED®
STONE

12MM

PIEDRA TECNOLÓGICA /
LOSA SINTERIZADA

1600 x 3200 x 12MM

**PIEDRA TECNOLÓGICA /
LOSA SINTERIZADA**

ALASKA WHITE

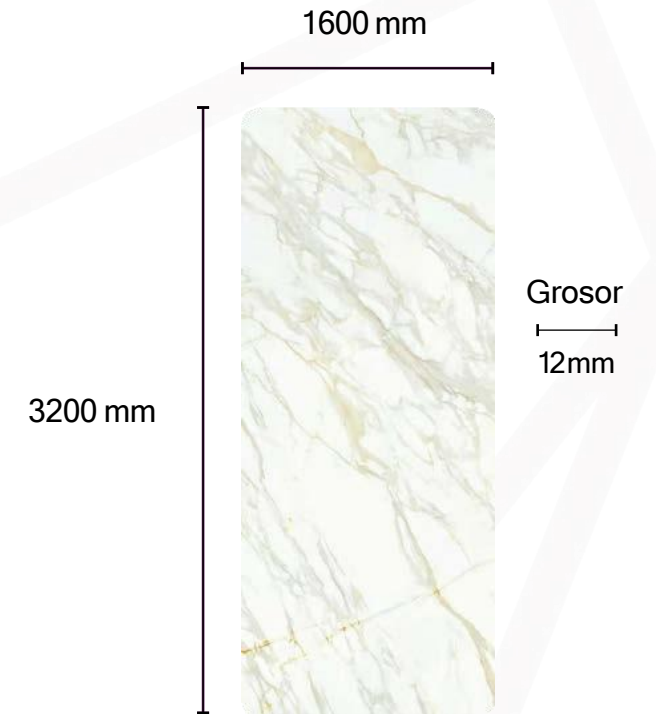

Acabado: **Pulido**

Secuencia Facial: **A B**

Ariston White



Acabado: **Mate**

Secuencia Facial: **A B C**

Bianco Bolomoty



Acabado: **Pulido**

Secuencia Facial: **U**

Bulgari White

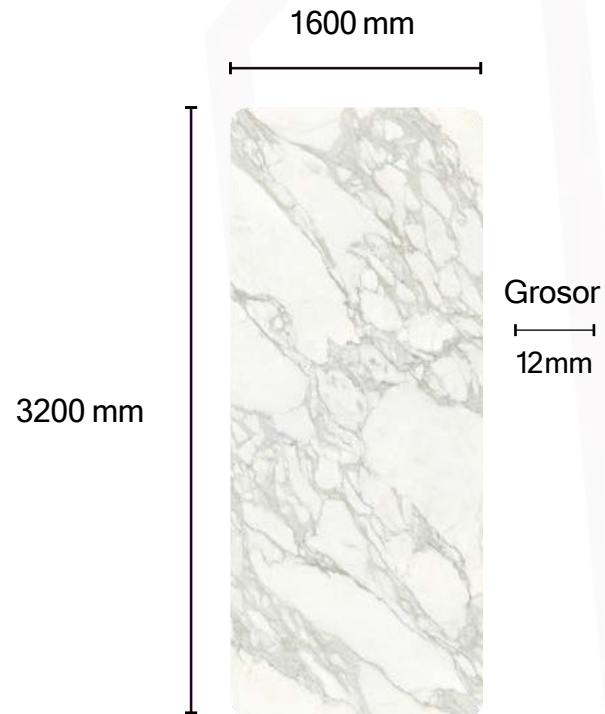

Acabado: **Mate**

Secuencia Facial: **A B C**

Calacatta Gold

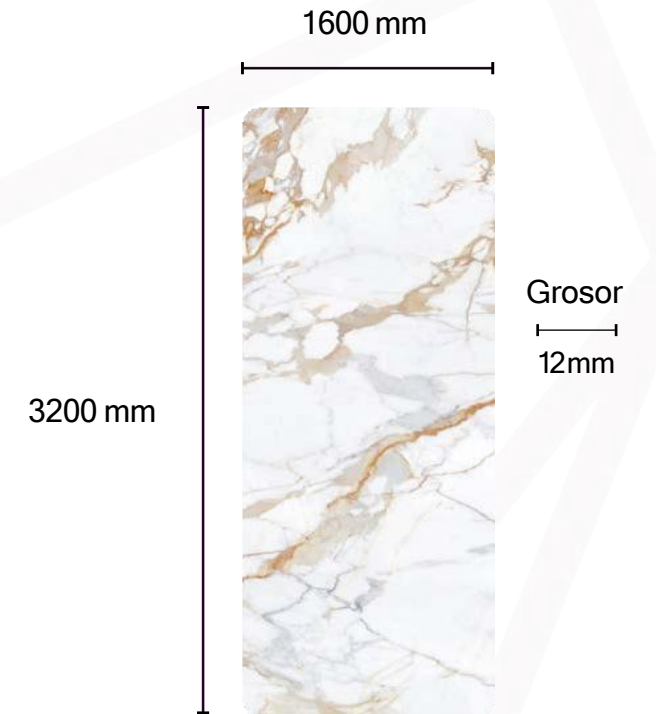

Acabado: **Mate**

Secuencia Facial: **A B C**

Calacatta Polido

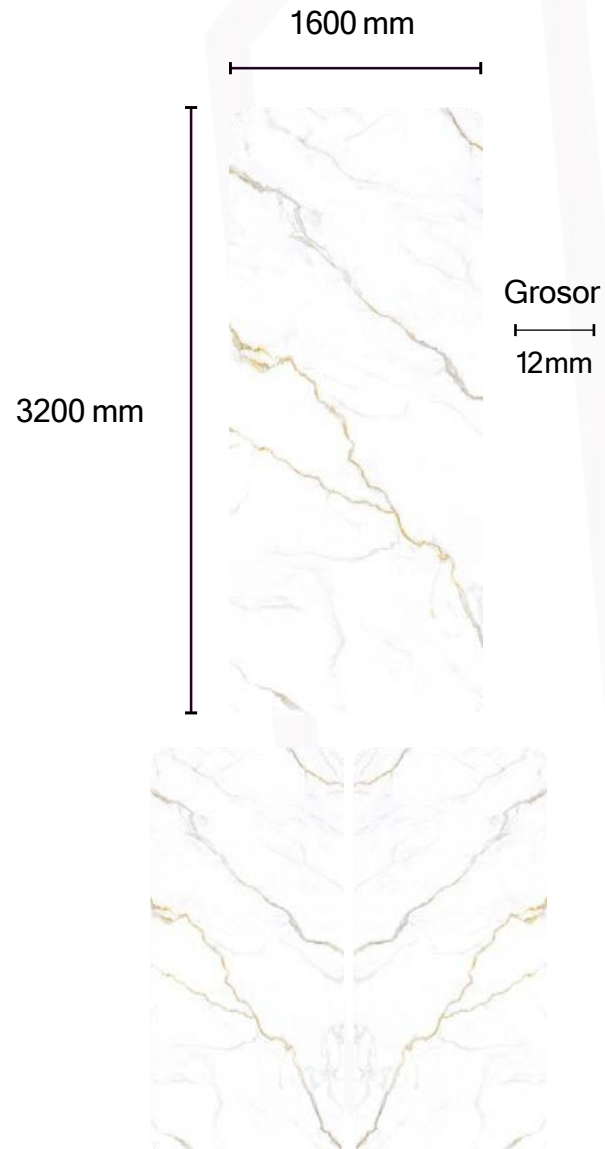

Acabado:

Pulido

Secuencia Facial:

A B

Calacatta Polido

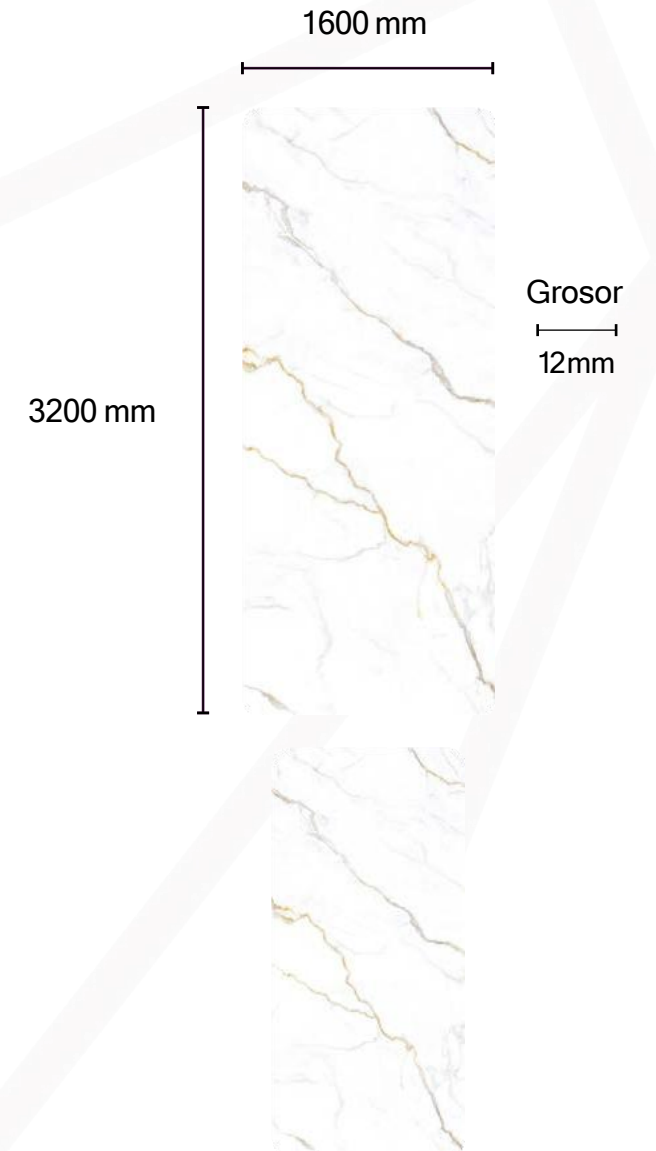

Acabado: **Mate**

Secuencia Facial: **U**

Cartier Gold

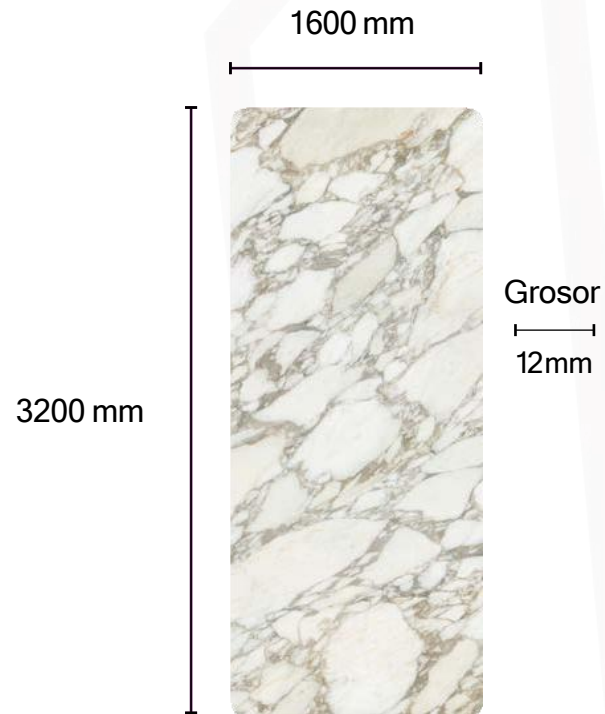

Acabado: **Mate**

Secuencia Facial: **A B C**

Crema Marfil Extra

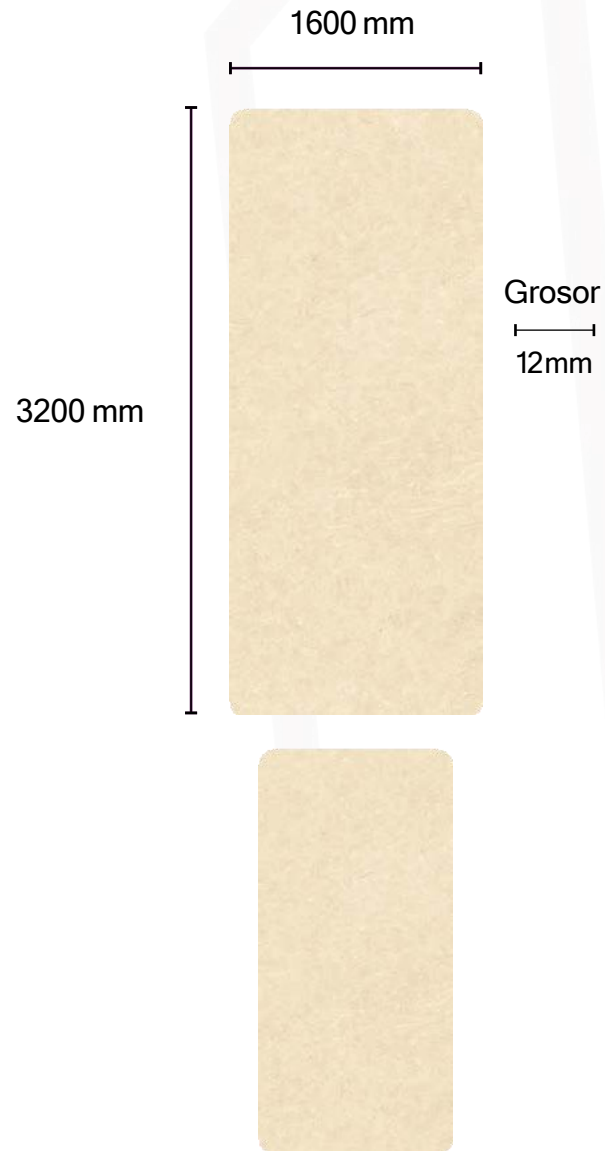

Acabado: **Mate**

Secuencia Facial: **U**

Panda White



Acabado: **Pulido**

Secuencia Facial: **A B C**

Roman Travertine

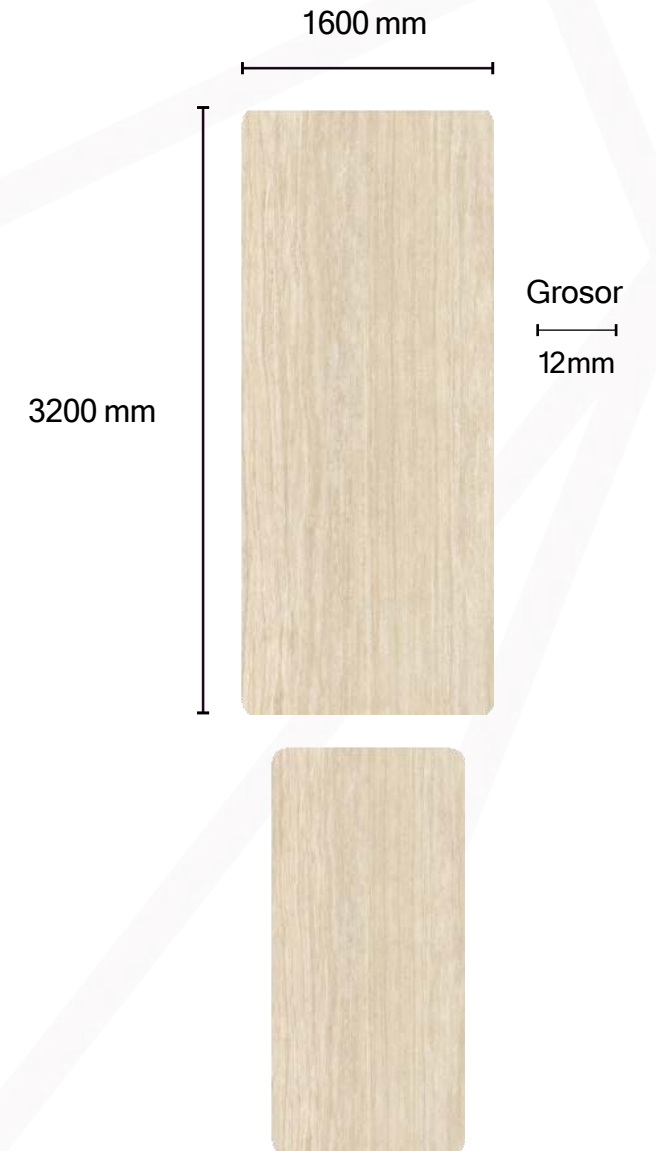

Acabado: **Mate**

Secuencia Facial: **U**

Statuario White

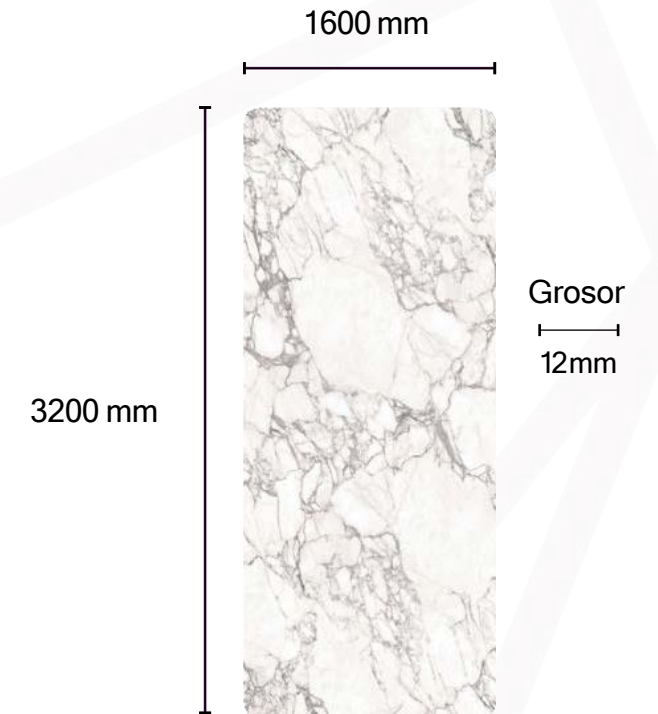

Acabado: **Mate**

Secuencia Facial: **A B C**

Taj Mahal

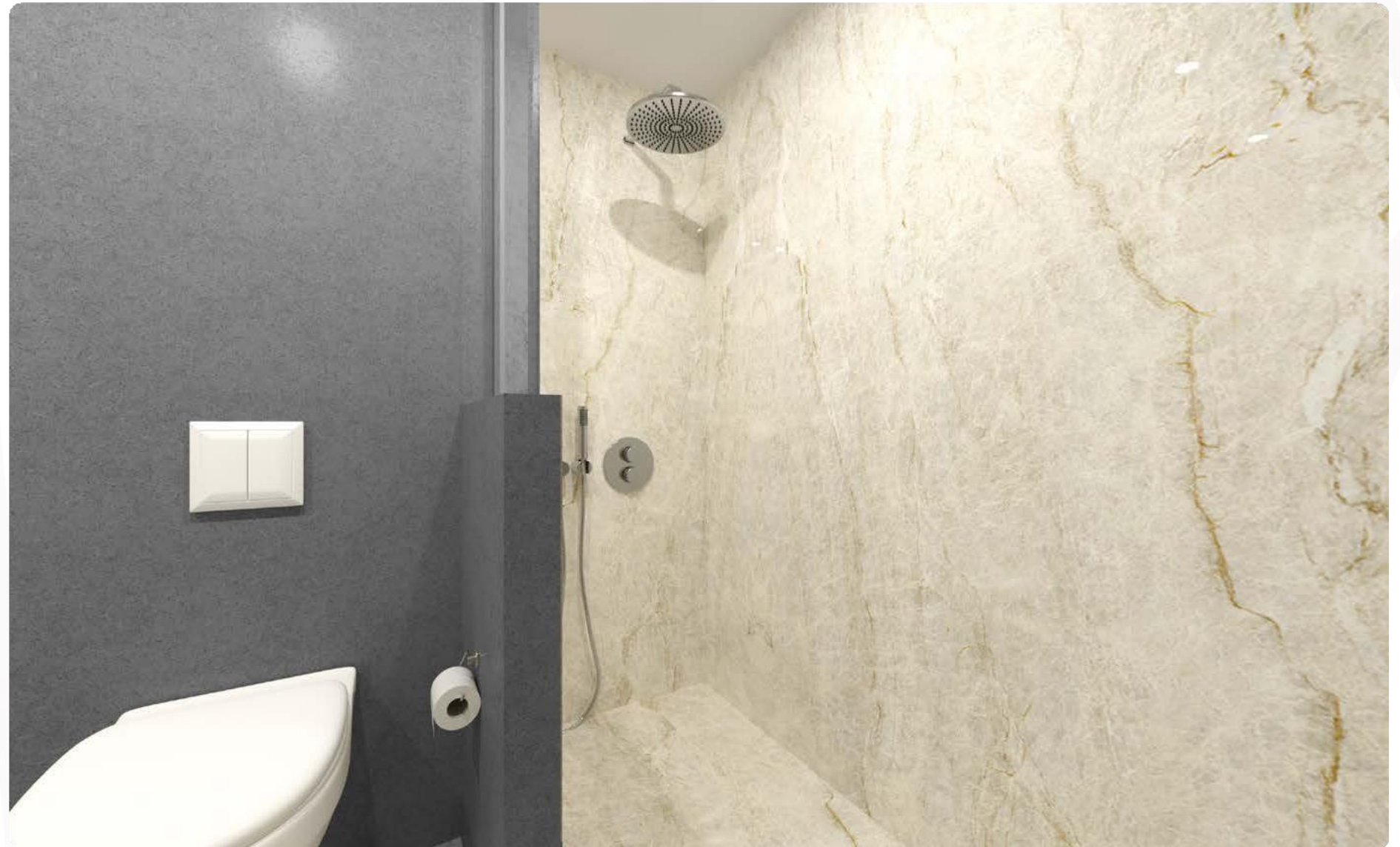

Acabado: **Pulido Suave**

Secuencia Facial: **A B**

White

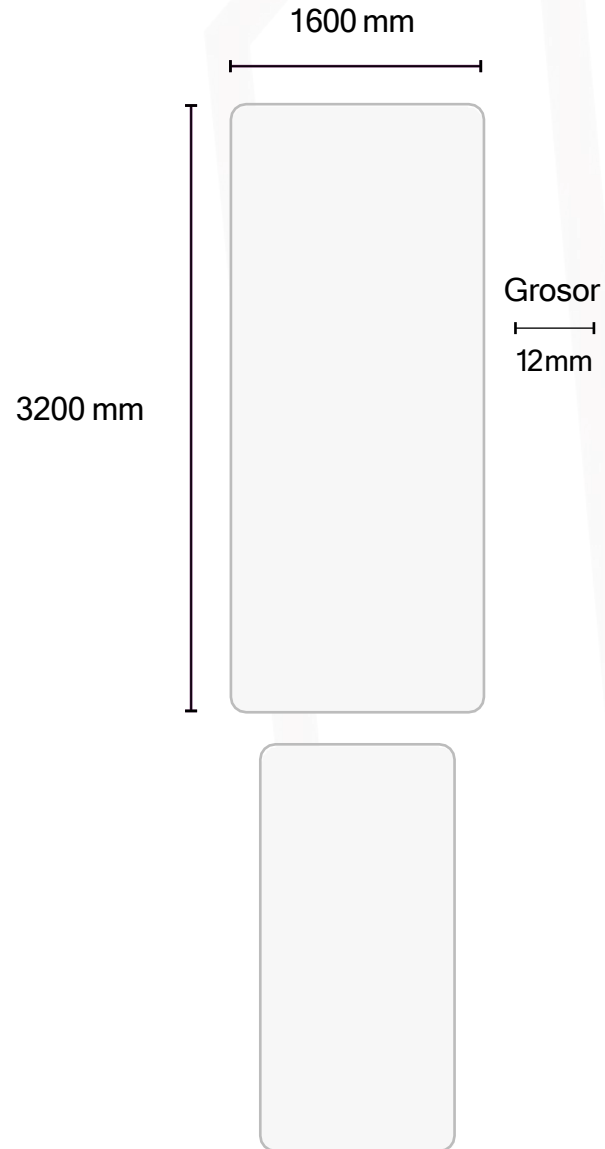

Acabado:

Pulido

Secuencia Facial:

U

Yabo White

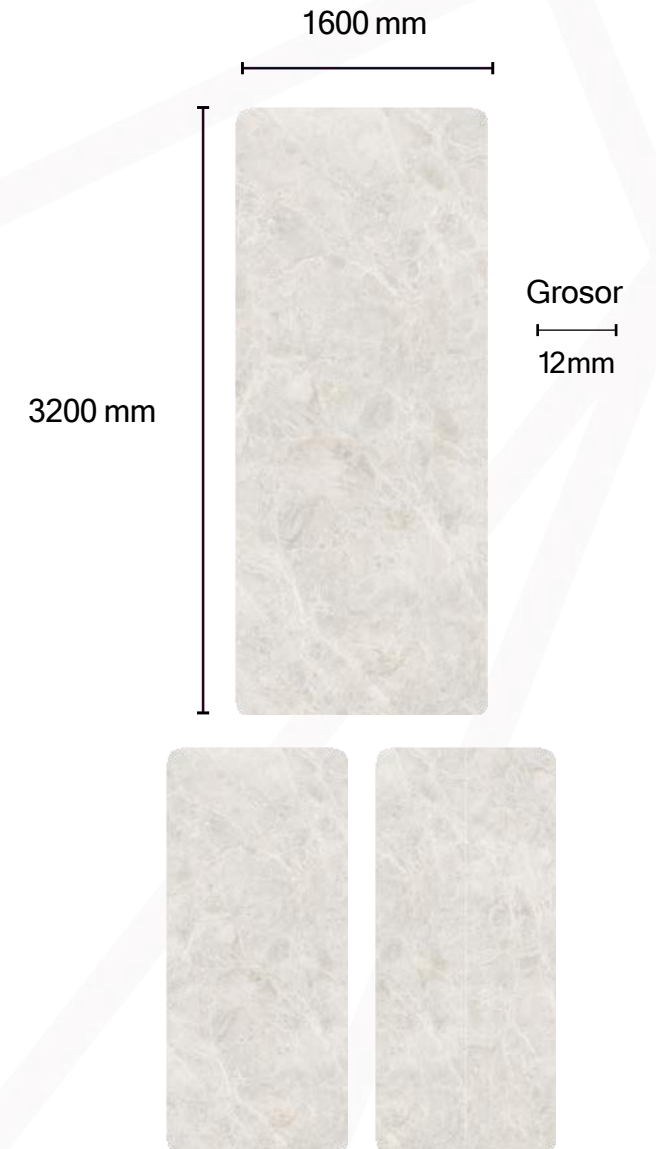

Acabado: **Mate**

Secuencia Facial: **A B**



1600 x 3200 x 12MM

COLOR BODY

**PIEDRA TECNOLÓGICA/
LOSA SINTERIZADA**

Amaranto

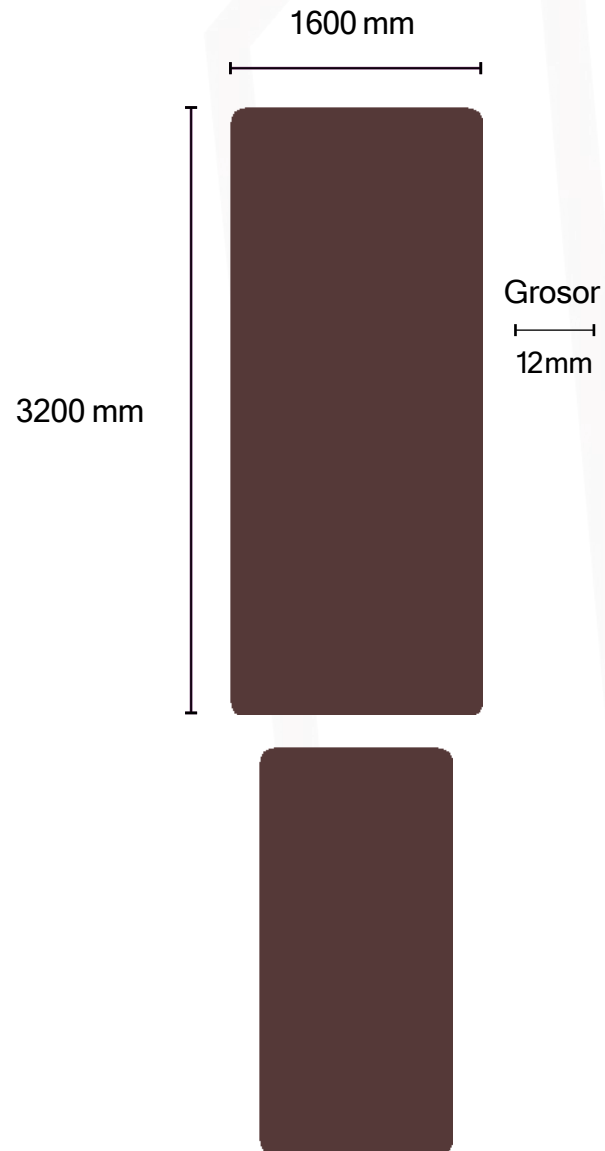

Acabado: **Mate Color Body**

Secuencia Facial: **U**

Basaltina Antracite

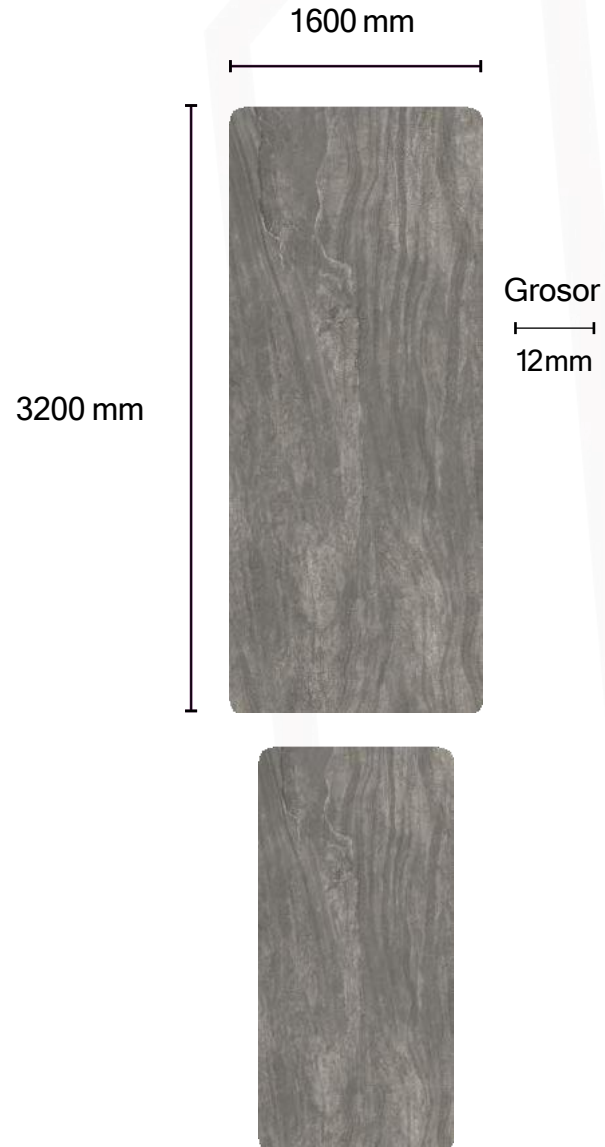

Acabado: **Mate Color Body**

Secuencia Facial: **U**

Corten

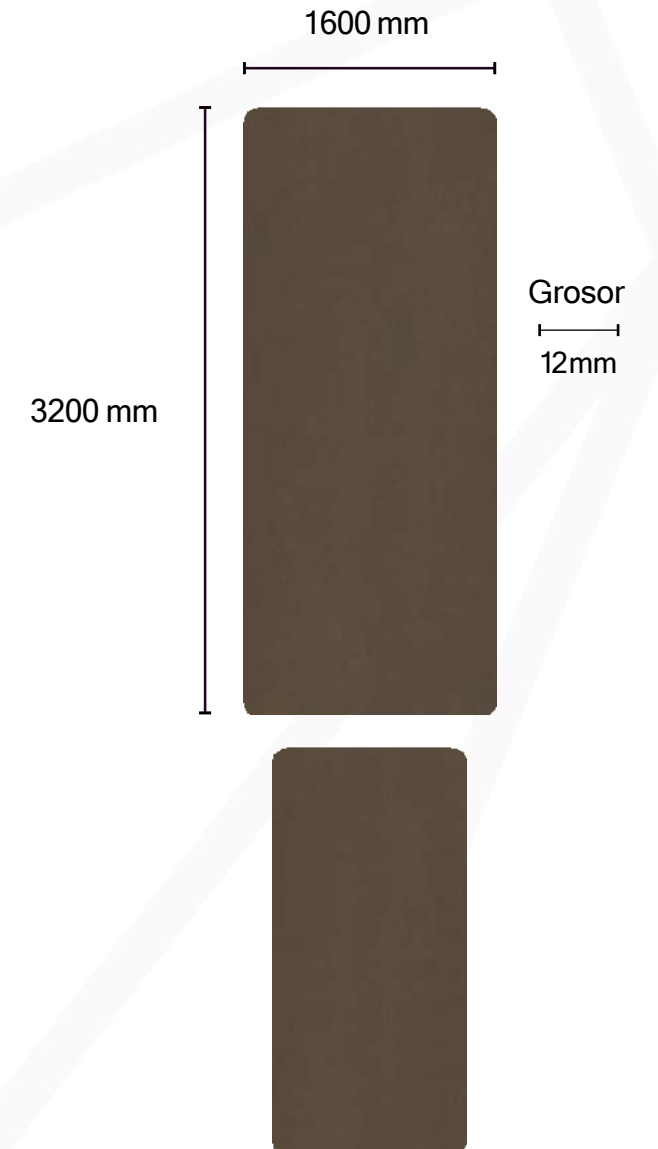

Acabado: **Mate Color Body**

Secuencia Facial: **U**

Classic Travertino

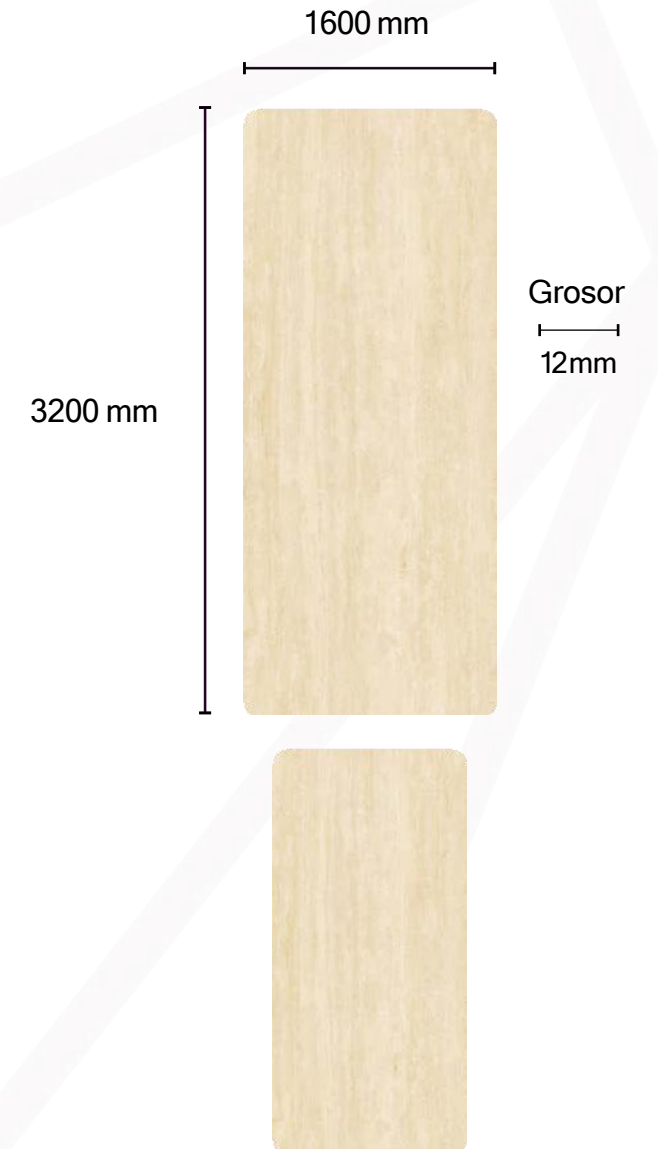

Acabado: **Mate Color Body**

Secuencia Facial: **U**

Galaxy Black



Acabado: **Mate Color Body**

Secuencia Facial: **A B**

Gothic Gold

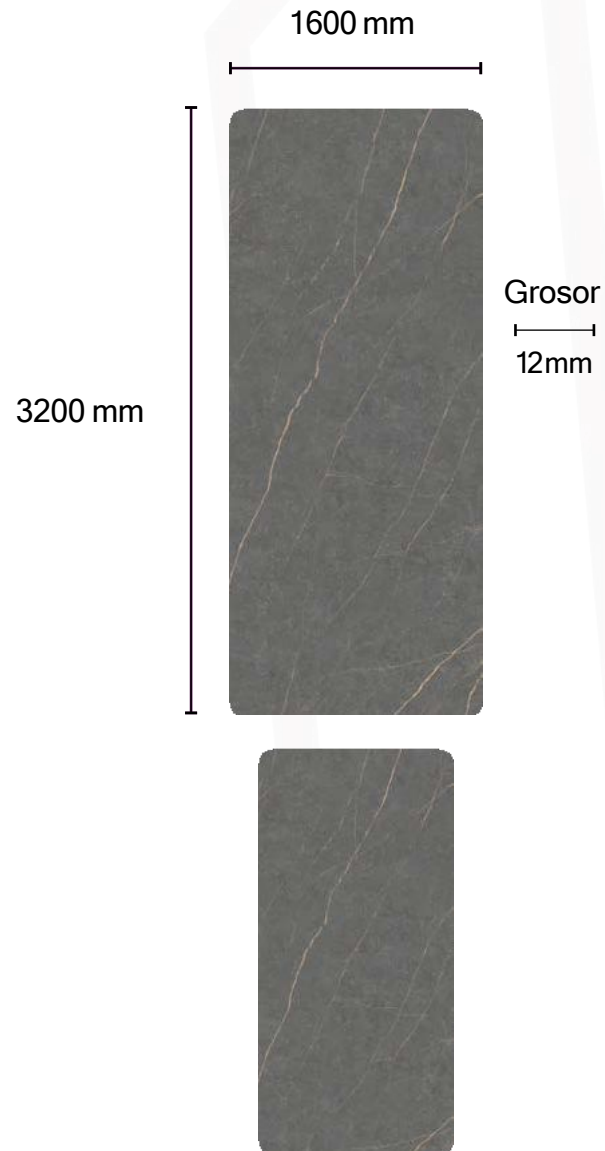

Acabado: **Mate Color Body**

Secuencia Facial: **U**

Iron Copper

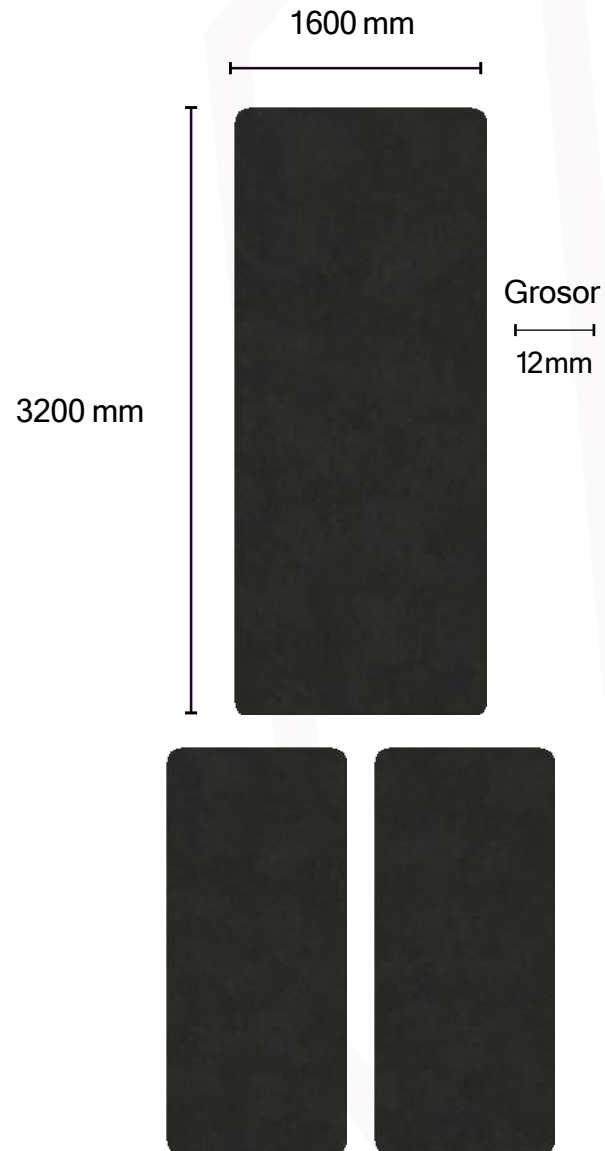

Acabado: **Mate Color Body**

Secuencia Facial: **A B**

Maserati Grey

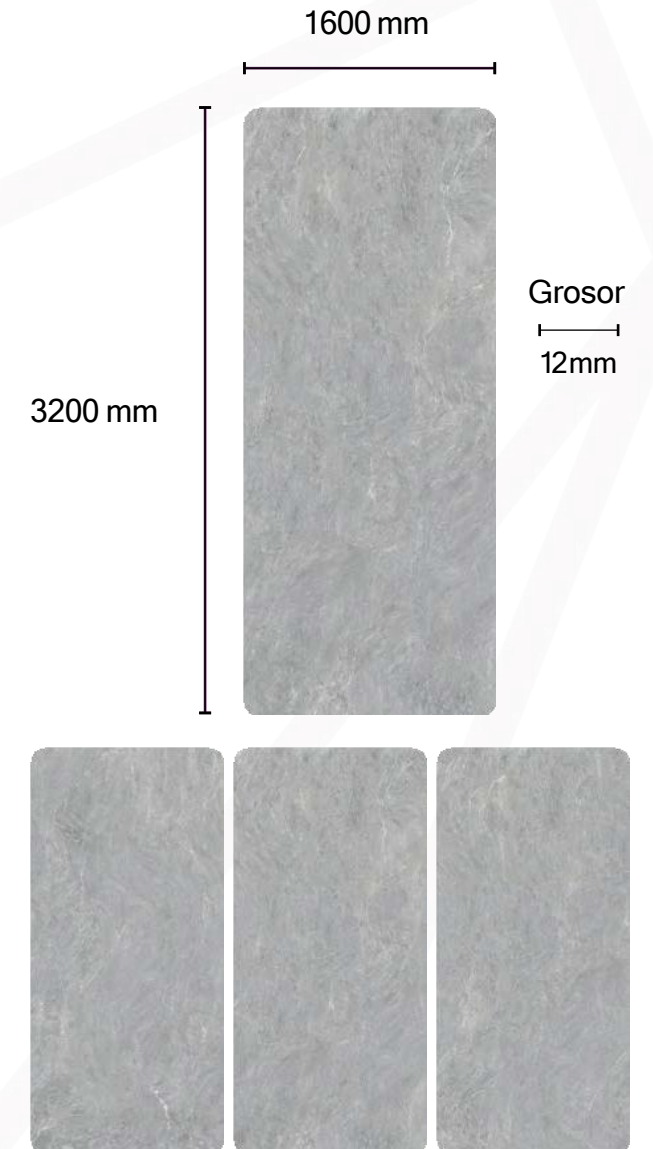

Acabado: **Mate Color Body**

Secuencia Facial: **A B C**

Minotaure Black

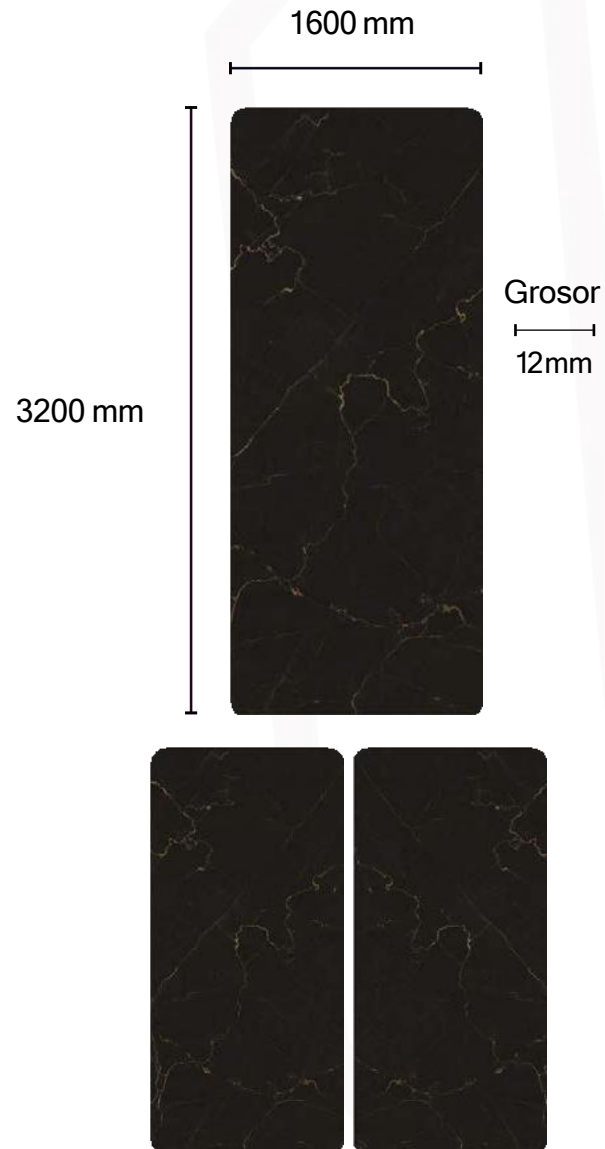

Acabado: **Pulido Color Body**

Secuencia Facial: **A B**

Napoleon Black

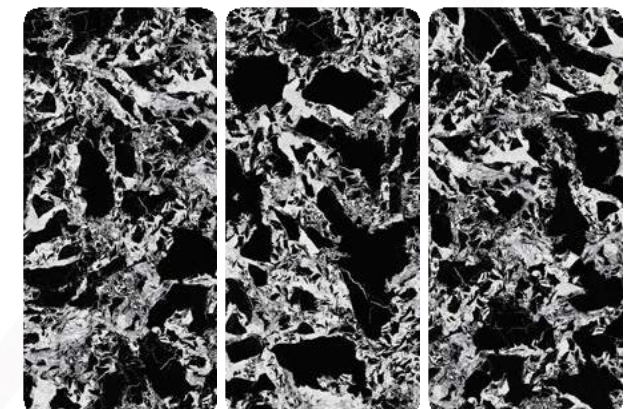
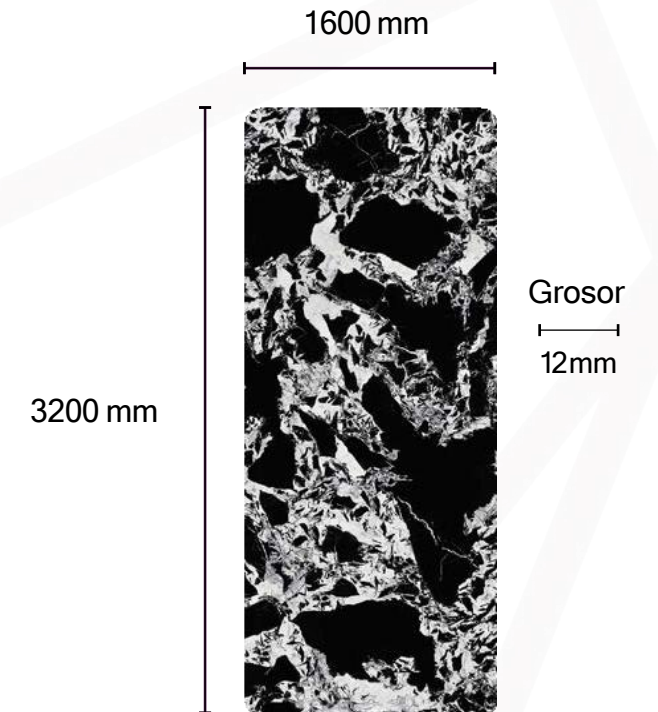

Acabado: **Mate Color Body**

Secuencia Facial: **A B C**

Nero Margiua

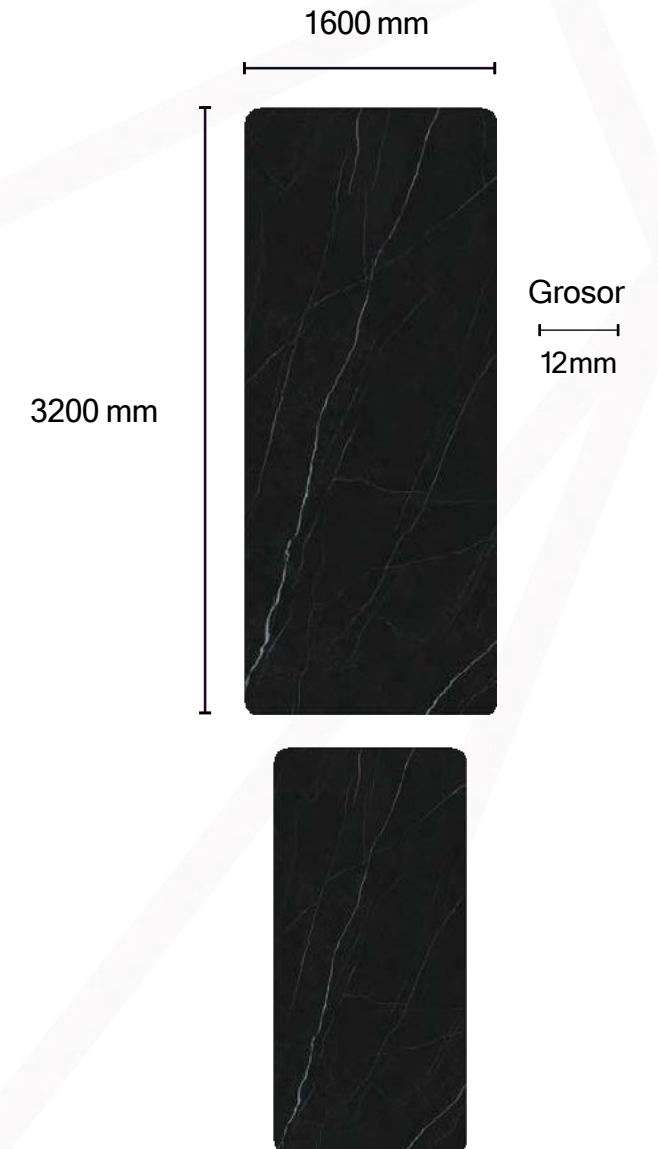

Acabado: **Pulido Color Body**

Secuencia Facial: **U**

Nero Margiua

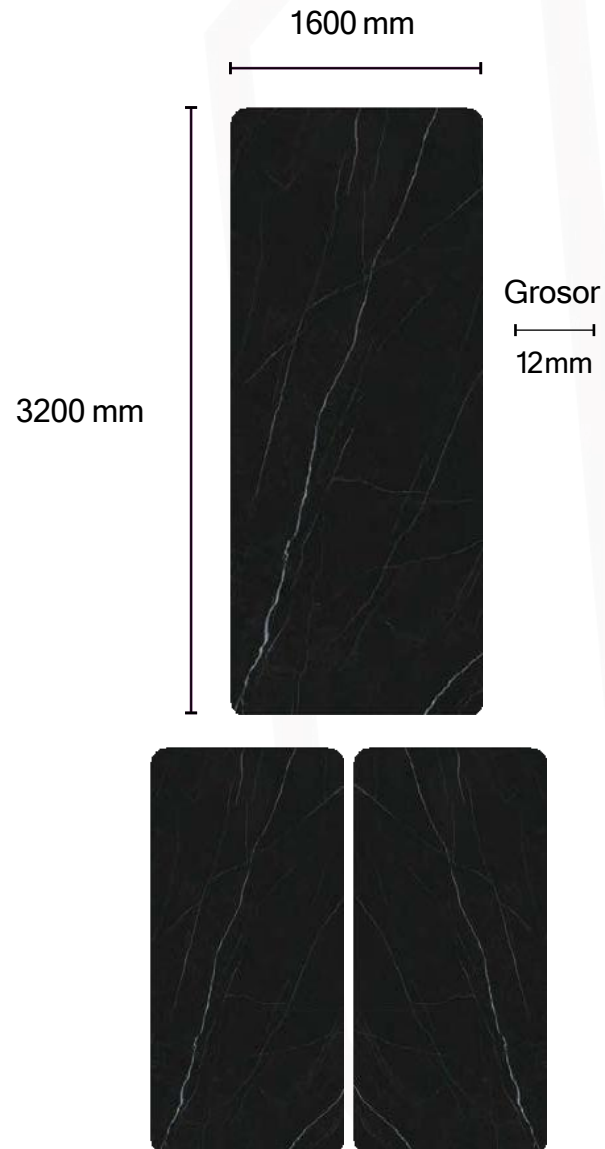

Acabado: **Mate Color Body**

Secuencia Facial: **A B**

Platinum Leica

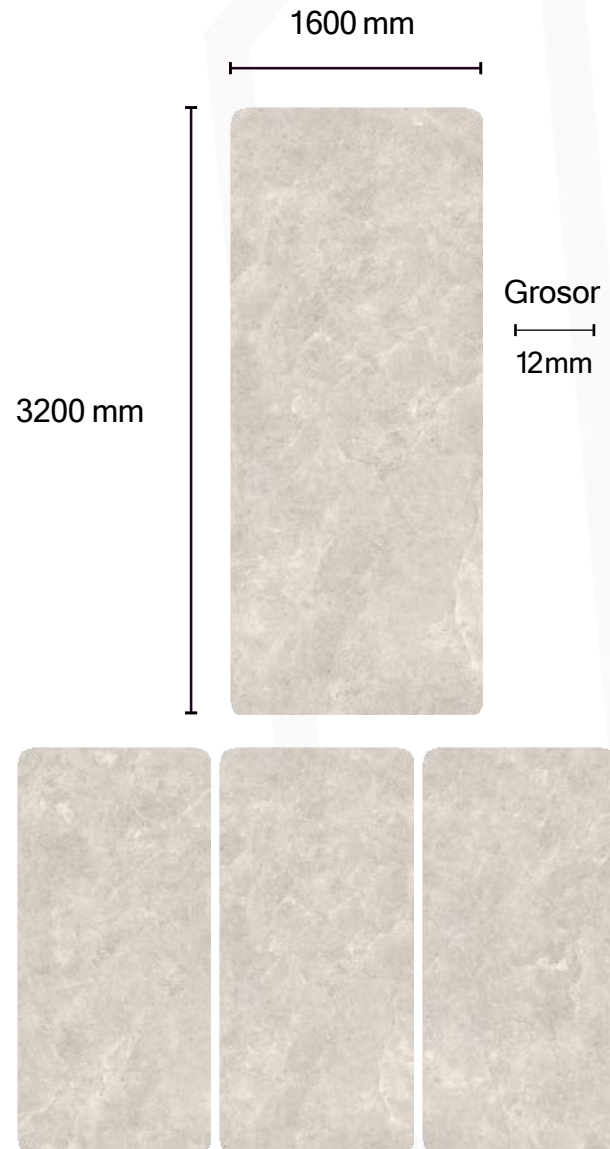

Acabado: **Mate Color Body**

Secuencia Facial: **A B C**

Pulpis

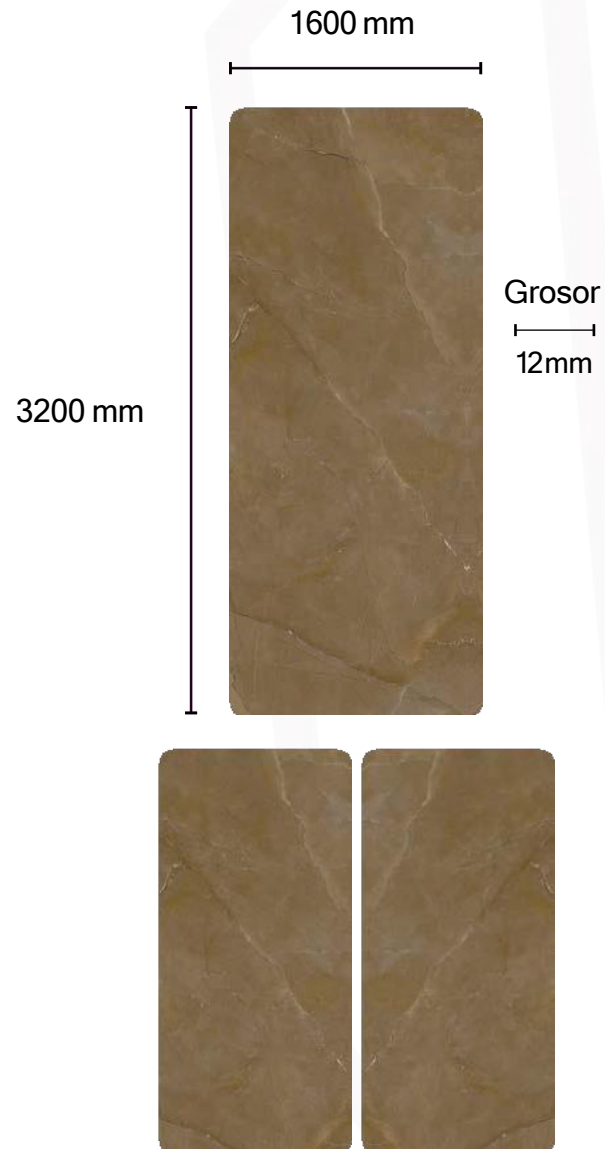

Acabado: **Mate Color Body**

Secuencia Facial: **A B**

Pure Black

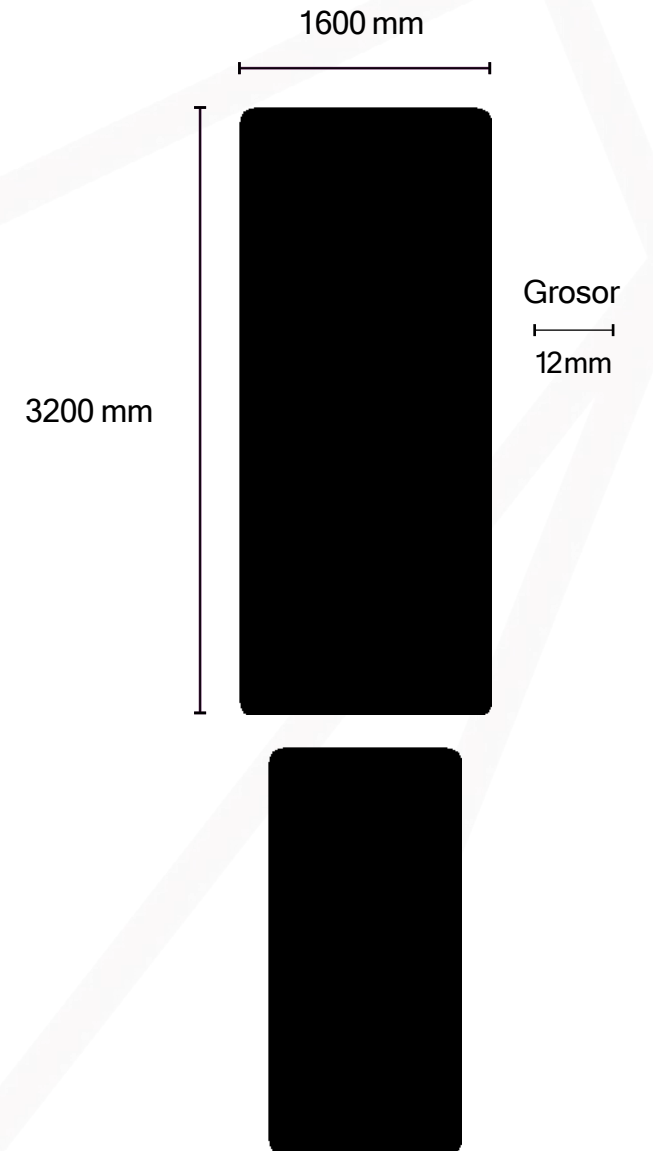

Acabado: **Mate Color Body**

Secuencia Facial: **U**

Pure Grey

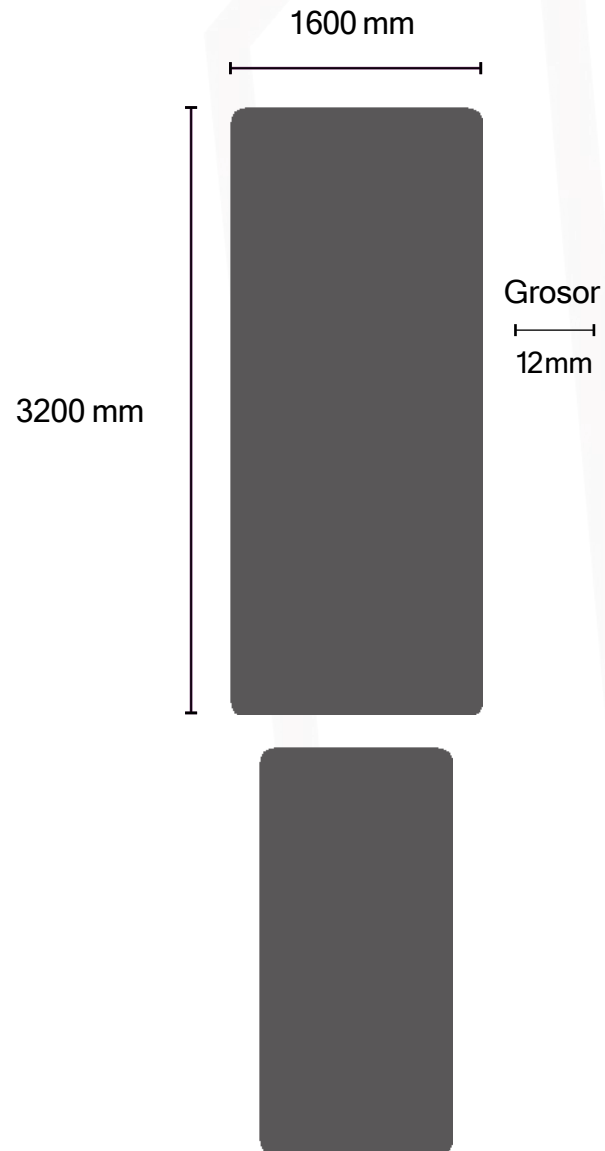

Acabado: **Mate Color Body**

Secuencia Facial: **U**

Sandy Grey Cream

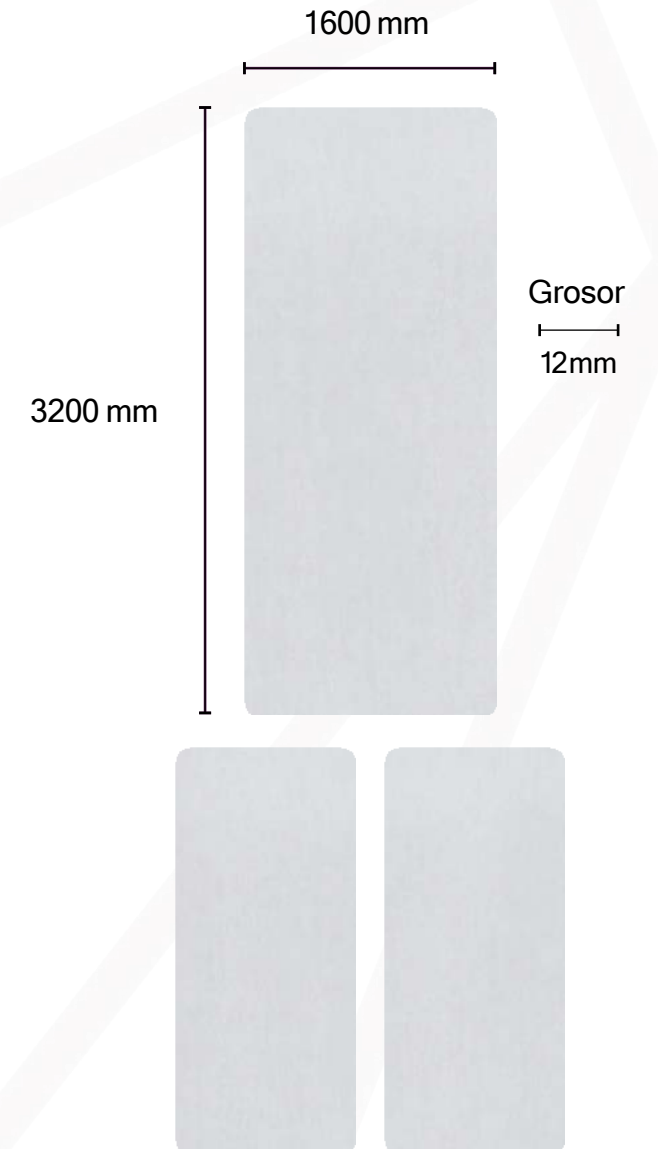

Acabado: **Mate Color Body**

Secuencia Facial: **A B**

Sandy Grey Dark

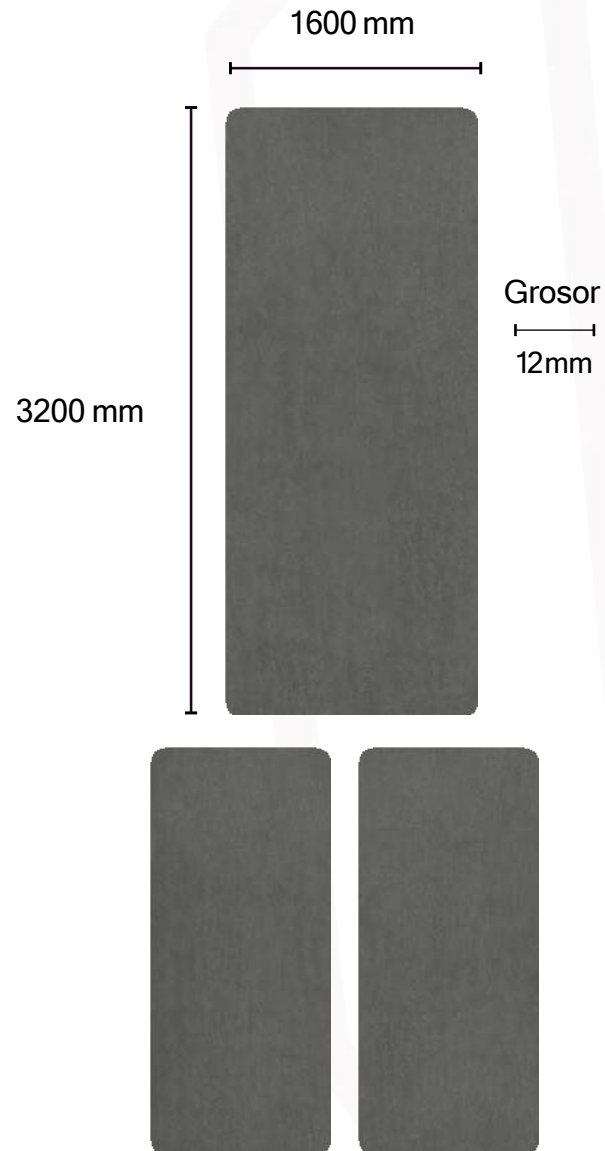

Acabado: **Mate Color Body**

Secuencia Facial: **A B**

Sandy Grey Ligth

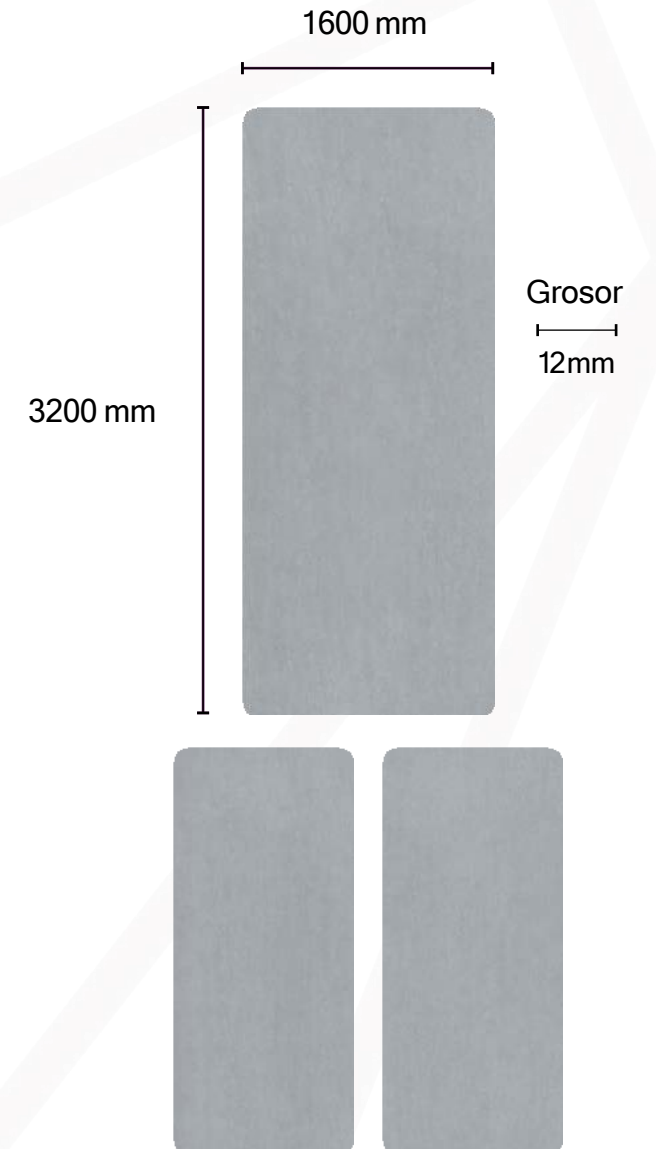

Acabado: **Mate Color Body**

Secuencia Facial: **A B**

Sandy Grey Media

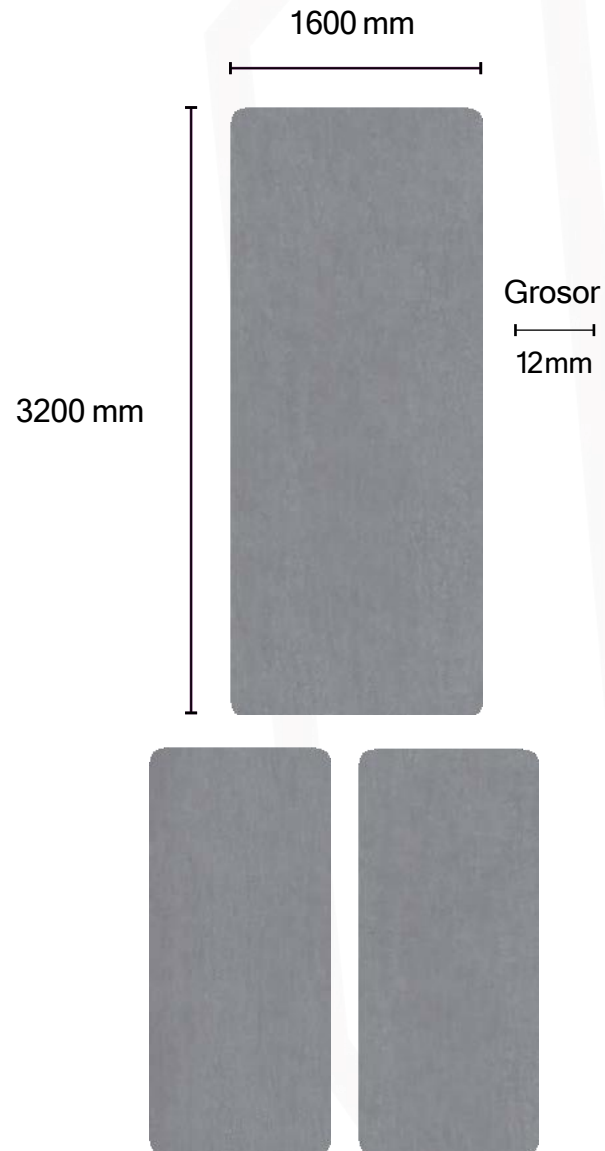

Acabado: **Mate Color Body**

Secuencia Facial: **A B**

Starry Seine

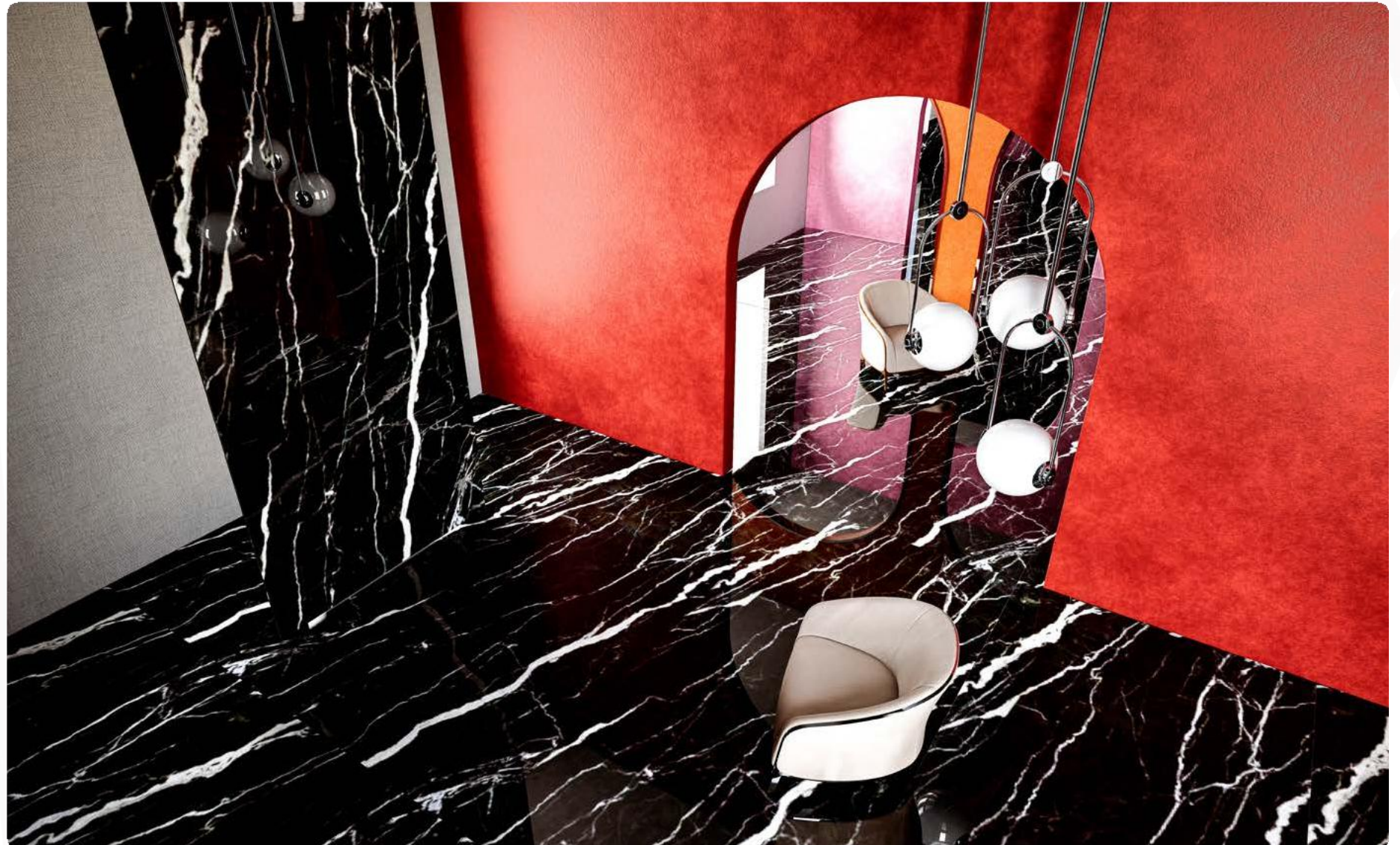
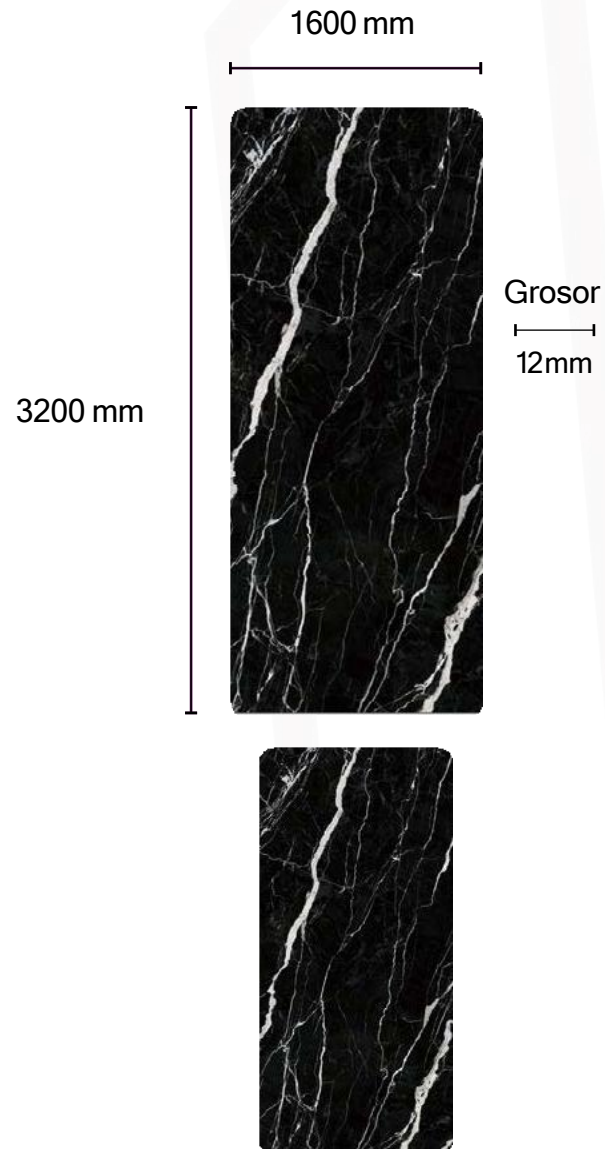

Acabado: **Pulido Color Body**

Secuencia Facial: **U**

Super White



Acabado: **Pulido Suave Color Body**

Secuencia Facial:

U

Van Gogh Grey

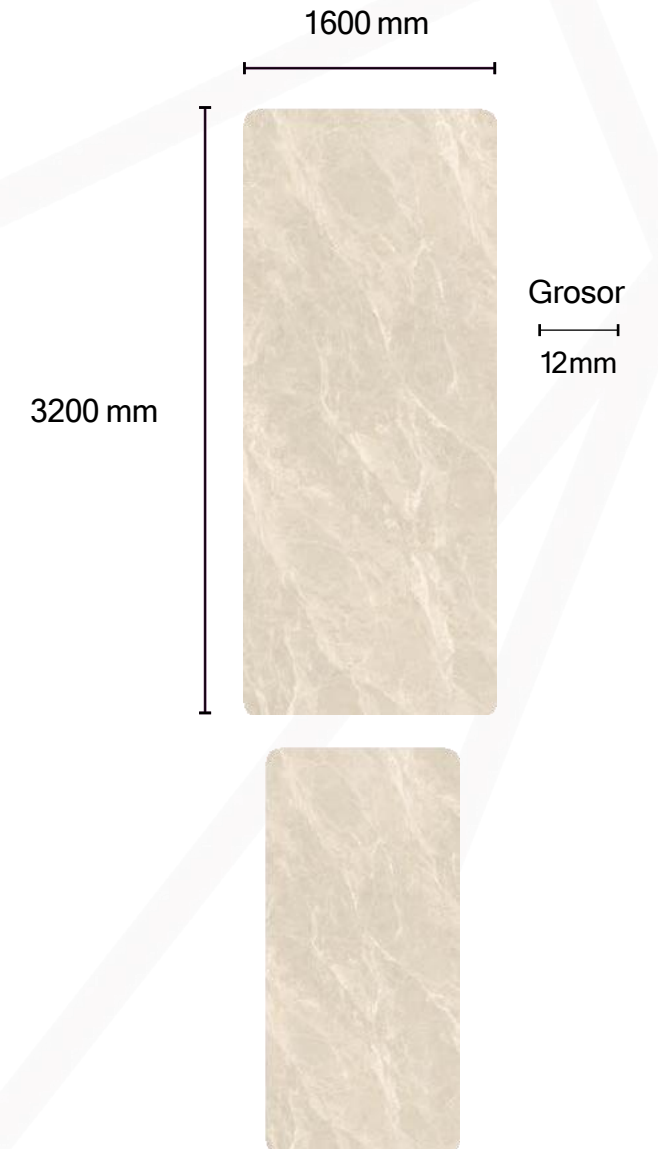

Acabado: **Pulido Suave Color Body**

Secuencia Facial: **U**

1600 x 3200 x 12MM

FULL BODY

**PIEDRA TECNOLÓGICA/
LOSA SINTERIZADA**

Alice Gold

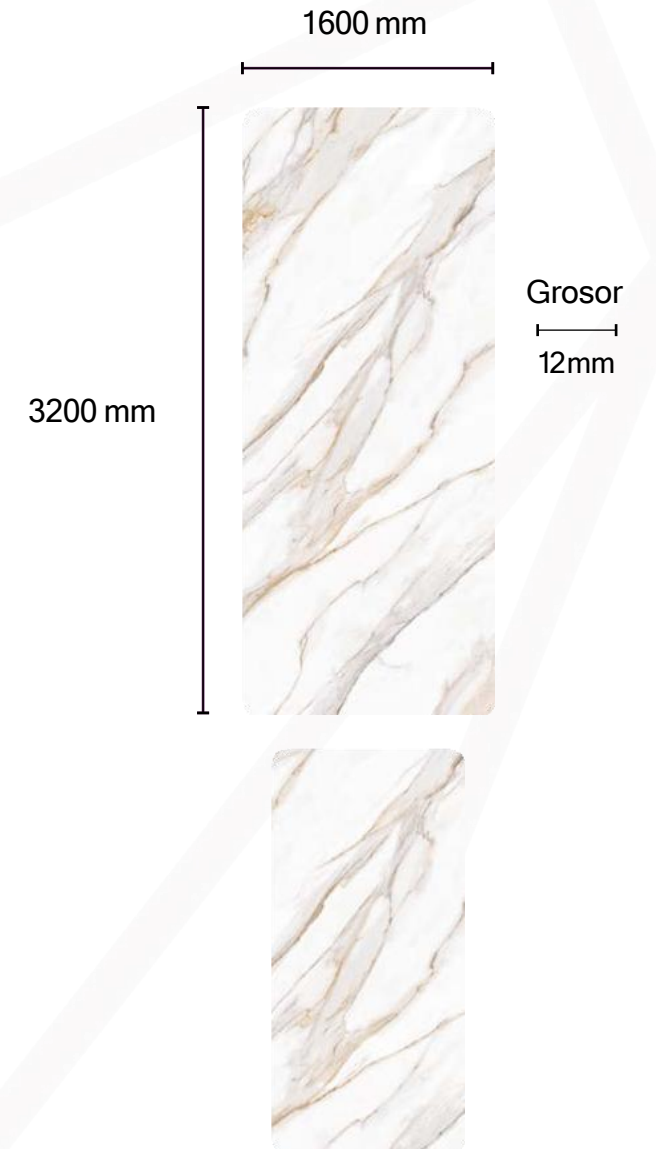

Acabado: **Mate Suave Full Body**

Secuencia Facial: **U**

Artic Ocean

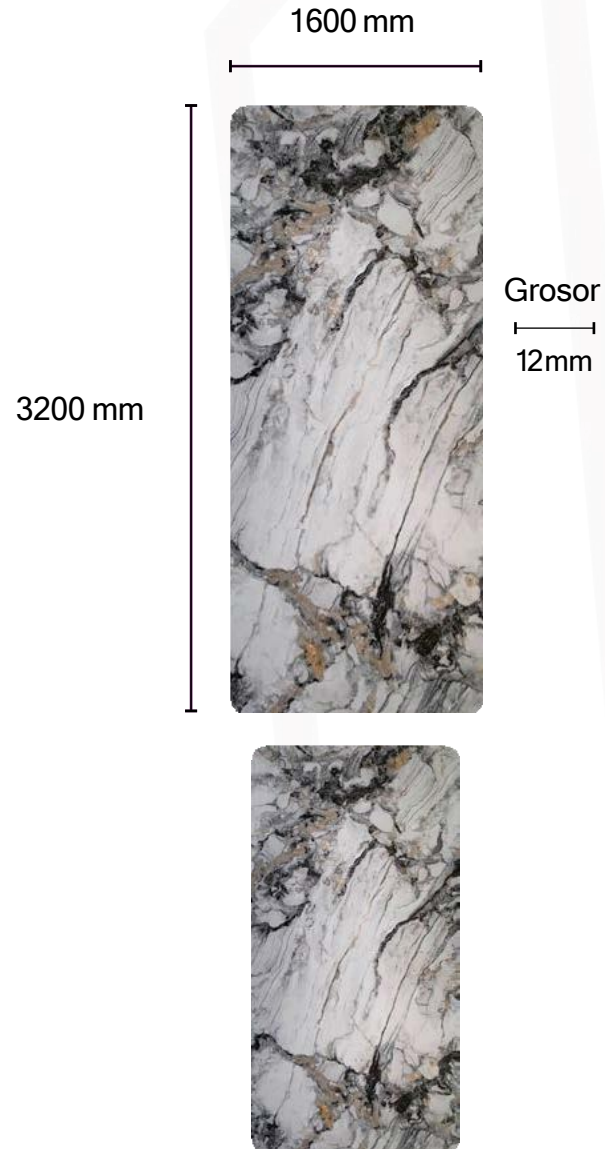

Acabado: **Mate Suave Full Body**

Secuencia Facial: **U**

Calacatta Lincoln



Acabado: Pulido Full Body

Secuencia Facial: A B

Gentleman White

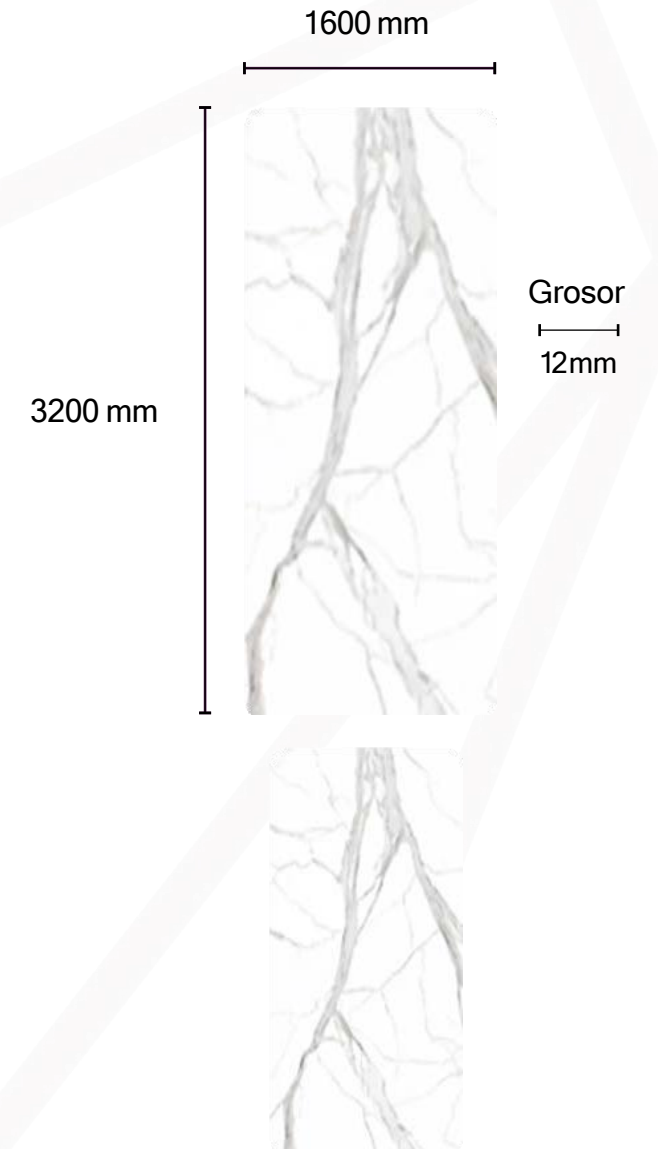

Acabado: **Mate Suave Full Body**

Secuencia Facial: **U**

Panda White

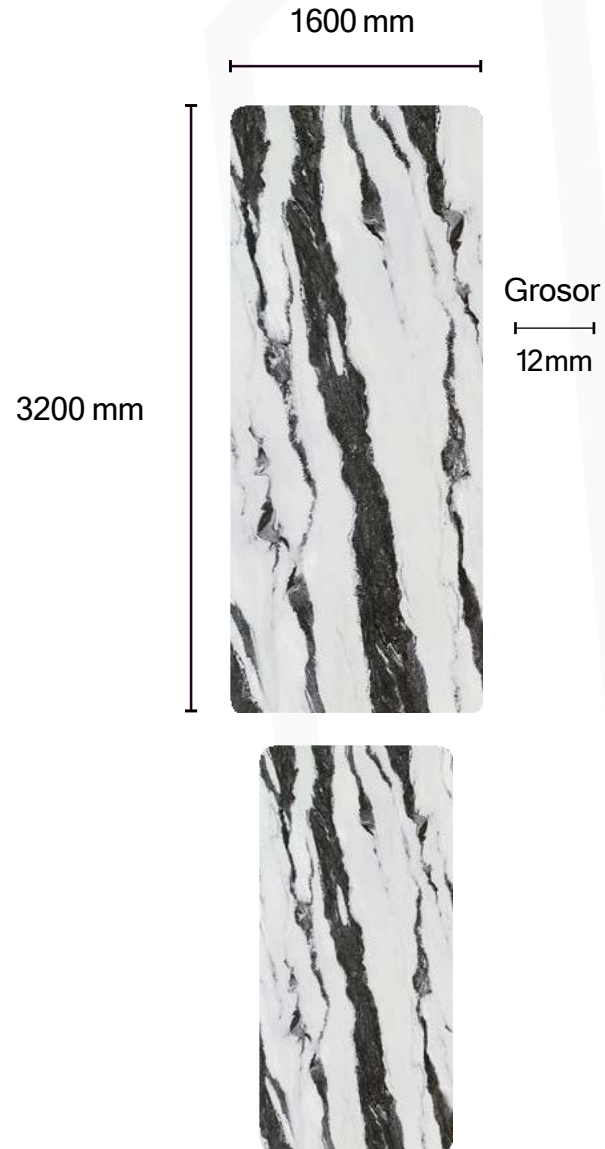

Acabado: **Mate Suave Full Body**

Secuencia Facial: **U**

Starry Seine

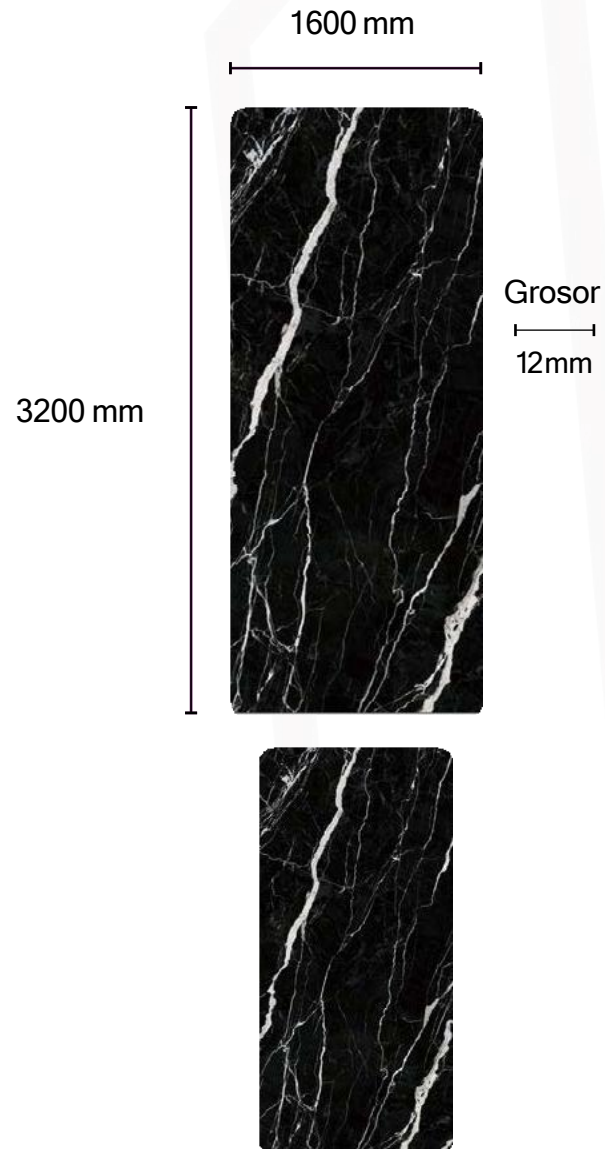

Acabado: **Mate Full Body**

Secuencia Facial: **U**



SINTERED[®]
S T O N E

www.sinteredstone.com.mx